

Since 1918

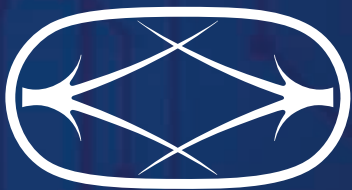

Kohan[®]

HOOKS & CASES

Kohan Hook Bobbin Case Shuttle Hook

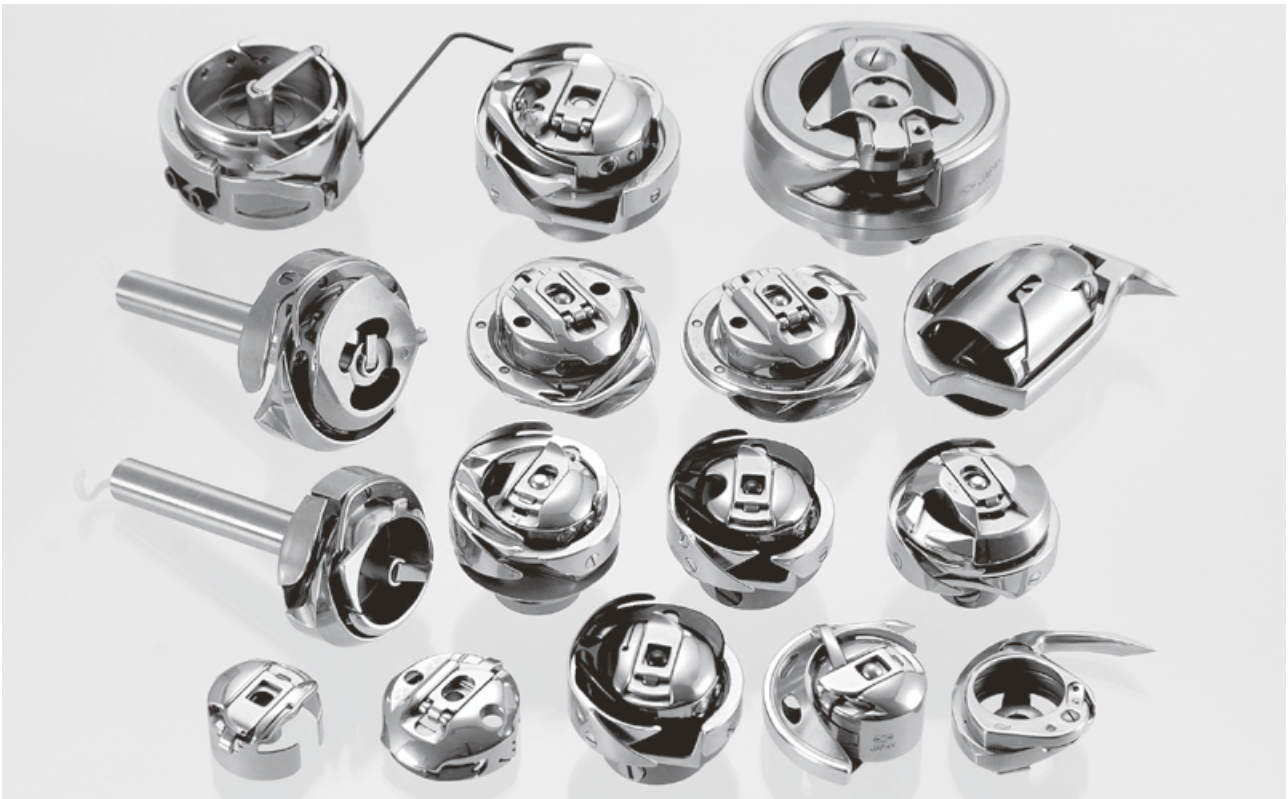

INTRODUCTION

SABUN INDUSTRIAL CO., LTD. was founded in 1918 as a textile manufacturer. The company started manufacturing Sewing Machine Parts in 1945, Since then it has been the specialist in Hook and Bobbin Case industry for more than 70 years.

The company has three factories in Niigata Prefecture, 300 km away from Tokyo and it has in total 25,000M2 of the ground, 10,500M2 of the building lot, where "KOBAN" Hooks and Cases are produced by continuous working system through a great number of processes, 300 for some items consisting of forging, lathing, milling, grinding, pressing, hardening and polishing. All these processes are worked by the newest model of Machining Centers (MC), Numerical Control Lathes (NC) and the specially designed machinery under production and quality control by computers and latest industrial technology.

The Hooks and Bobbin Cases with the brand, "KOBAN" are supplied not only to world wide sewing machine makers, such as JUKI, BROTHER, MITSUBISHI, SEIKO, TAJIMA, BARUDAN, ZSK etc., but also to over 30 foreign makers in Taiwan, Korea, China and so on, who have highly appreciated their quality, cost and delivery. Furthermore "KOBAN" Hooks and Bobbin Cases are supplied as spare parts to the apparel industries more than 80 countries.

SABUN INDUSTRIAL CO.,LTD. JAPAN 株式会社 佐文工業所 日本

Head office : 2-1-41, Motomachi, Kounan-ku,
Niigata-City, Niigata 950-0143, Japan
Tel : +81-25-382-8110 Fax : +81-25-382-7352
E-mail : koban-hd@sabun.co.jp URL : <http://www.sabun.co.jp>

CLASSIFIED LISTING AND DESCRIPTION















ROTARY HOOK HIGH SPEED TYPE: KHS12	1
ROTARY HOOK HIGH SPEED LARGE TYPE: KHS20	4
ROTARY HOOK HIGH SPEED TYPE: OTHER	7
ROTARY HOOK LOW SPEED TYPE:KR	8
ROTARY HOOK HIGH SPEED ZIGZAG TYPE: KRP	10
ROTARY HOOK STANDARD TYPE WITH SHAFT: KRT	11
ROTARY HOOK LARGE TYPE WITH SHAFT: KRT	13
ROTARY HOOK STANDARD TYPE WITHOUT SHAFT: KRT	15
ROTARY HOOK SPECIAL TYPE: KRT	17
SHUTTLE HOOK MISCELLANEOUS PARTS: KSP.....	18
ROTARY HOOK LARGE TYPE WITHOUT SHAFT: KRT	19
SHUTTLE HOOK: SH.....	21
CAP: SCP	23
BOBBIN CASE STANDARD TYPE: SC.....	24
BOBBIN CASE LARGE TYPE: SC	26
BOBBIN CASE ZIGZAG TYPE: SC	27
BOBBIN CASE SPECIAL TYPE: SC	28

REFERENCE TO SEWING MACHINES

ABLE (美宝)	31	MELCO	61
BAIPU (百普)	31	MILLION SPECIAL (萬特)	61
BAOMA (寶馬)	31	MITSUBISHI (三菱)	62
BAOYU (寶宇)	31	NECCHI (尼奇)	65
BARUDAN (百靈達)	32	NEW-TECH	66
BEYOUNG (本佳)	32	NITAKA (日高)	66
BROTHER (兄弟)	32	PANDA (建聯)	67
BUTTERFLY (蝴蝶)	37	PEGASUS (飛馬)	67
CHIKON (奇鋼)	37	PEMAL (良機)	68
CHNKI (中縫)	38	PFAFF (百福)	68
CHUAN NENG (傳能)	38	PRECIOUS (匯寶)	70
CHUAN WANG (莊旺)	38	PRINCE	71
CHURCHILL (求精)	38	PROTEX (通宇)	71
CONSEW (康秀)	39	RICHPEACE (富怡)	71
CUEY FENG (貴峰)	39	SANGOOD (雙角)	72
DADILI (大地利)	40	SEIKO (精工)	72
DALIAN (大連)	40	SEWTECH (縫科科技)	75
DOSO (大森)	40	SEWSTAR (莊旺)	75
DURKOPP/ADLER (杜克普/愛華)	40	SHANGGONG (上工)	75
FANG HUNG (方宏/PLATINA)	41	SICAMA (安機)	76
FEIYUE (飛躍)	41	SINGER (勝家)	76
FENG YING (鋒穎)	41	SIRUBA (高林)	81
FLYINGMAN (飛人)	41	STAGER (津久井)	83
FOMAX	41	SUNNUN (信能)	83
GEMSY (寶石)	42	SUNSTAR (日星)	83
GLOBAL	42	TAJIMA (田島)	86
GOLDEN WHEEL (金輪)	43	TAKING (天王星)	86
HIGHLEAD (海菱)	47	TONY (輝煌)	87
HIKARI (富山)	49	TOYOTA (豐田)	87
HUANAN (華南)	49	TREASURE (珠寶)	88
JACK (傑克)	49	TTY (大羽)	88
JAKI (佳島)	51	TYPICAL (標準)	88
JANOME (真善美)	51	TYPICAL WANPING (苑坪)	90
JUITA (川田)	51	UNICORN (神馬)	91
JUKI (重機)	51	UNION SPECIAL (於仁)	92
JUMBO KING (象王)	58	YAKUMO (八云)	92
KAISER (凱瑟)	59	YAMATO (大和)	93
K-CHANCE (高機)	59	YULUN (友倫)	94
KERDER (客德)	60	YXSM (裕祥)	94
KING'S (王品)	60	ZGM (珠光)	94
KINGTEX (精機)	60	ZOJE (中捷)	95
MAQI (美機)	60	ZSK	96

* = EXCLUSIVE ITEMS

ROTARY HOOK HIGH SPEED TYPE : KHS12

KHS12-2S	KHS12-G	KHS12-GN Teflon
 <p>JUKI DDL-127, 5530N, -5550, -5550N, -8700 DDL-8100E, -8300, -8500</p> <p>φ 7.94</p>	 <p>SINGER 281</p> <p>φ 7.94</p>	 <p>SINGER 281</p> <p>φ 7.94</p>
 <p>JACK JK-8500H SUNSTAR KM-350B TYPICAL GC6-8A/-8B ZOJE ZJ5580-5 ZJ5600N ZJ8500-5</p> <p>φ 7.94</p>	 <p>HIGHLEAD GC0518-HD JUKI DDL-555H-4-5, -5580H MITSUBISHI LS2-1180-H SUNSTAR KM-2300S(M)-B TYPICAL GC6-8-D2</p> <p>φ 7.94</p>	 <p>GOLDEN WHEEL CS-8703-BT JUKI DSC-244/-4/-6 YAKUMO 681</p> <p>φ 7.94</p>
 <p>JUKI DSC-244/-4/-6 DSC-245-4/-5/-6 ZOJE ZJ2628</p> <p>φ 7.94</p>	 <p>BROTHER DB2-B755-5 HIGHLEAD GC128-H,188-H/-HL MITSUBISHI DY-370-12 LS2-1280-H1TW TYPICAL GC6150M/6150H ZOJE ZJ8800-5</p> <p>φ 7.94</p>	 <p>BROTHER DB2-B790-5/-B791-5</p> <p>φ 7.94</p>
 <p>TOYOTA AD340B</p> <p>φ 7.94</p>	 <p>GEMSY 8900H-7, 8957EB SIRUBA L918-H1-□</p> <p>φ 7.94</p>	 <p>YAKUMO 681</p> <p>φ 7.94</p>
 <p>FOR EMBROIDERY</p> <p>φ 7.94</p>	 <p>FOR EMBROIDERY</p> <p>with teflon coated WONDER base</p> <p>φ 7.94</p>	 <p>FOR EMBROIDERY</p> <p>φ 7.94</p>

Teflon HOOK BASE TEFLON















DLC HOOK BASE DLC COATING
MINIMAL OIL

Ti HOOK BASE
TITANIUM COATING

ADJ ADJUSTABLE STRONG
NEEDLE GUARD

N WITH NON SLIP SPRING

* = EXCLUSIVE ITEMS

ROTARY HOOK HIGH SPEED TYPE : KHS12		
<p>KHS12-RYPICC DLC</p> <p>(KHS12-RYPICC+SC34-2NS) FOR EMBROIDERY</p>  <p>φ 7.94</p> <p>※Hook, Bobin case are sold separately.</p>	<p>KHS12-RYP4EICC DLC</p> <p>(KHS12-RYP4EICC+ SC34-2NS) FOR EMBROIDERY</p>  <p>φ 7.94</p> <p>※Hook, Bobin case are sold separately. HIGH SPEED, FOR WIDE VARIETY OF THREAD</p>	<p>KHS12-RYPN Teflon</p> <p>FOR EMBROIDERY</p>  <p>φ 7.94</p> <p>with teflon coated base</p>
<p>KHS12-RYPOE</p> <p>FOR EMBROIDERY</p>  <p>φ 7.94</p> <p>HIGH SPEED</p>	<p>KHS12-RYPOEICC DLC</p> <p>(KHS12-RYPOEICC+ SC34-2NS) FOR EMBROIDERY</p>  <p>φ 7.94</p> <p>※Hook, Bobin case are sold separately. HIGH SPEED</p>	<p>KHS12-RYPOEOJ2</p> <p>FOR EMBROIDERY</p>  <p>φ 7.94</p> <p>HIGH SPEED, with lublctation</p>
<p>KHS12-RYPOEOJ2ICC DLC</p> <p>FOR EMBROIDERY</p>  <p>φ 7.94</p> <p>HIGH SPEED, with lublctation</p>	<p>KHS12-RYPW</p> <p>FOR EMBROIDERY</p>  <p>φ 7.94</p> <p>with WONDER base</p>	<p>KHS12-S</p> <p>JACK JK-8500 MITSUBISHI DB-170-10/-171 DN-350-12 LS2-1130-MOB SINGER 400W, 402W, 600W ZOJE ZJ8600/8700/8800</p> <p>φ 7.94</p>
<p>KHS12-SB2</p> <p>BROTHER DB2-B714-1/-B736-1/-3, -B757-3/-5, -B758, -B773-3/-A DB2-B781/-1/-2-3, -B792-003/-013/-015/- 017, -B795-013. UNICORN LS2-H530</p>  <p>φ 7.94</p>	<p>KHS12-SB3OHO</p> <p>BROTHER DB2-B736-5 S-1110A-5 TYPICAL GC6100HD</p>  <p>φ 7.94</p>	<p>KHS12-SD</p> <p>BROTHER DB2-B771/-B790/-B791-3 JUKI DLN-5410 SERIES, -5410N SERIES</p>  <p>φ 7.94</p>
<p>KHS12-SPB</p> <p>BROTHER DB2-B737-3/- B738-3/-B778/- B7740/-B7741 DB2-B774/-B7740/- B7741/-B778/- DD7100 S-7200A-403/-433 SL-2010-3/-778A-3</p>  <p>φ 7.94</p>	<p>KHS12-SPB3OHO</p> <p>BROTHER BAS-301 DB2-B737-5, -B738- 5, -B790-5-0/-505, -B791-5-0 S-7200A-405/-1010- 5/-2010-5/-737A-5, S-7200B-305 SL-2010-5/-737A-5</p>  <p>φ 7.94</p>	<p>KHS12-SPD3</p> <p>BROTHER DB2-B790-3/-303,-B791-333 GLOBAL NF-331-AUT</p>  <p>φ 7.94</p>

Teflon 特氟隆內釜





DLC 像鑽石一樣堅硬的石炭塗層內釜

Ti 鈦塗層

ADJ 护針片調整旋梭

N 附防止空轉彈簧片

* = EXCLUSIVE ITEMS

ROTARY HOOK HIGH SPEED TYPE : KHS12		
<p>KHS12-SPD2</p>  <p>φ 7.94</p>	<p>BROTHER DB2 SERIES S-7200</p> <p>JACK A4/A5</p> <p>JUKI DDL-8000A DDL-9000A, -9000B-SS</p> <p>MITSUBISHI LS2-1780-M1TW LS2-2210-M/-2210-M1T/-M1TW</p> <p>SUNSTAR KM-250A-7 KM-350A-7</p> <p>UNICORN LS2-H5200/-H5300/-H5500/-H6000-D</p> <p>ZOJE ZJ8500-D3</p>	<p>KHS12-SPD2ICC DLC</p>  <p>φ 7.94</p>
<p>KHS12-SPD4</p>  <p>φ 7.94</p>	<p>KHS12-SPD6</p>  <p>φ 7.94</p>	
<p>GOLDEN WHEEL CS-5100BT</p>	<p>JACK JK-5878-58</p>	

Teflon HOOK BASE TEFLON

DLC HOOK BASE DLC COATING
MINIMAL OIL















Ti HOOK BASE
TITANIUM COATING

ADJ ADJUSTABLE STRONG
NEEDLE GUARD

N WITH NON SLIP SPRING

* = EXCLUSIVE ITEMS

ROTARY HOOK HIGH SPEED LARGE TYPE : KHS20

<p>KHS20-GTB</p>  <p>BROTHER DB2-B745-5 JUKI DDL-5600NJ/NU/NL SEIKO H-2BL-AE-1 SUNSTAR KM-146BL/-340BL TYPICAL WANPING GC0302</p> <p>φ 7.94</p>	<p>KHS20-GTMP</p>  <p>HIGHLEAD GC0398-1D GC0518-BD GC128-B-D3 MITSUBISHI DB-189-22BZ LS2-1780-B1T/-180</p> <p>φ 7.94</p>	<p>KHS20-GTVG</p>  <p>SEIKO HC-2BL/-1 HCLH-2BL LSC-8BL, -8BLV-1 SUNSTAR KM-380BL TYPICAL WANPING TW3-S336VB</p> <p>φ 7.94</p>
<p>KHS20-HPEW</p>  <p>GOLDEN WHEEL CS-8113/-8713 JUKI DNU-241H, -261H DSC-246/-4/-6 SUNSTAR KM-590B/-591BL</p> <p>φ 7.94</p>	<p>KHS20-R</p>  <p>GOLDEN WHEEL CS-6102/-6103 JACK JK-6318 JUMBO KING WR-5705 MILLION SPECIAL MS-3811L</p> <p>φ 7.94</p>	<p>KHS20-R1E</p>  <p>SEIKO HCL-2BL</p> <p>φ 7.94</p>
<p>KHS20-R2E</p>  <p>JUKI DSU-144N</p> <p>φ 7.94</p>	<p>KHS20-RM2</p>  <p>HIGHLEAD GC2358-1 JUMBO KING WR-3750 MITSUBISHI DB-325-22/-327 LY2-3300-BOB TYPICAL GC6180 ZOJE ZJ8500H</p> <p>φ 7.94</p>	<p>KHS20-RM3</p>  <p>JUKI DSC-246-4/-6, DSC-246V-4/-6 DU-1181N/-**A SEIKO HC-2BL/-1</p> <p>φ 7.94</p>
<p>KHS20-RMP</p>  <p>BROTHER BAS-412/-416/-423 BE-1201B-AC DB2-B748-307 GC0618, -668-D JK-6380D PLK-G**R SERIES SUNSTAR KM-250BL-7K/-7S TYPICAL GC6-5/-6/-7 UNICORN LS2-H5150XH</p> <p>φ 7.94</p>	<p>KHS20-RMPN</p>  <p>GOLDEN WHEEL CS-8713-BT JUKI DSC-246-4/-6, DSC-246V-4/-6</p> <p>φ 7.94</p>	
<p>KHS20-RMPNW</p>  <p>JUKI DNU-1541-7</p> <p>φ 7.94</p>	<p>KHS20-RP1ECC</p>  <p>GOLDEN WHEEL CS-6210/-6220</p> <p>φ 7.94</p>	<p>DLC KHS20-RP1EKS</p>  <p>JUKI AMS-224EN- ***AW3(太糸用=FOR THICK THREAD)</p> <p>φ 7.94</p>

Teflon 特氟隆内釜

DLC 像鑽石一樣堅硬的石炭塗層内釜















Ti 鈦塗層

ADJ 护针片調整旋梭

N 附防止空轉彈簧片

* = EXCLUSIVE ITEMS

ROTARY HOOK HIGH SPEED LARGE TYPE : KHS20

<p>KHS20-RPE</p>  <p>CONSEW 205RBH TYPICAL WANPING GC3002CX</p> <p>φ 7.94</p>	<p>KHS20-RPEM2AO</p>  <p>CONSEW 206RB/306RB JUKI DNU-241HS, -1541S TYPICAL WANPING TW1-0602</p> <p>φ 7.94</p>	<p>KHS20-RPM2</p>  <p>GOLDEN WHEEL CS-6120D MITSUBISHI DY-339-22</p> <p>φ 7.94</p>
<p>KHS20-RPNG</p>  <p>PAFF KSM-200</p> <p>φ 7.94</p>	<p>KHS20-RPO</p>  <p>SEIKO SSH-8BLD, -8BLDC, STH-8BL, STH SERIES</p> <p>φ 7.94</p>	<p>KHS20-RST</p>  <p>GOLDEN WHEEL CSZ-3211 JUMBO KING WR-1125N SEWSTAR CW-1105/-1125/-1135 CW-1205/-1208/- 1225/-1235</p> <p>φ 7.94</p>
<p>KHS20-RT</p>  <p>JUKI LZH-1290/-4/-6</p> <p>φ 7.94</p>	<p>KHS20-RTB</p>  <p>BROTHER DB2-B745-5/-7, -B746-7, -B771, -B797-5 SL-746A</p> <p>φ 7.94</p>	<p>KHS20-RY</p>  <p>FOR EMBROIDERY</p> <p>φ 7.94</p>
<p>KHS20-RYP</p>  <p>FOR EMBROIDERY</p> <p>φ 7.94</p>	<p>KHS20-RYPICC</p>  <p>FOR EMBROIDERY</p> <p>φ 7.94</p>	<p>KHS20-RYPN</p>  <p>FOR EMBROIDERY</p> <p>φ 7.94</p>
<p>KHS20-S</p>  <p>CONSEW 120 TOYOTA D324 YAKUMO DSN-178L-2</p> <p>φ 7.94</p>	<p>KHS20-SMP</p>  <p>BROTHER BAS-350/-360/-361 DB2-B748A CHNKI GC812/913 JACK JK-T10080-10-022 MAQI PFM90533 TYPICAL WANPING GC0302-D2</p> <p>φ 7.94</p>	<p>KHS20-ST</p>  <p>CONSEW 175/175RB TOYOTA D530/530E/532 D533/534</p> <p>φ 7.94</p>

Teflon HOOK BASE TEFLON



DLC HOOK BASE DLC COATING
MINIMAL OIL

Ti HOOK BASE
TITANIUM COATING

ADJ ADJUSTABLE STRONG
NEEDLE GUARD

N WITH NON SLIP SPRING

* = EXCLUSIVE ITEMS

ROTARY HOOK HIGH SPEED LARGE TYPE : KHS20		
<p>KHS20-TZ</p>  <p>CONSEW 146RB GOLDEN WHEEL CS-2390/-2391 JUMBO KING WR-335-901-X2 STAGER SZ-21 SERIES</p> <p>φ7.24</p>	<p>KHS20-TZS</p>  <p>SEIKO LZ2-990, -992 SERIES</p> <p>φ7.94</p>	

Teflon 特氟隆内釜







DLC 像鑽石一樣堅硬的石炭塗層内釜

Ti 鈦塗層

ADJ 护针片調整旋梭

N 附防止空轉彈簧片

* = EXCLUSIVE ITEMS

ROTARY HOOK HIGH SPEED TYPE : OTHER		
<p>KHS1183-SP</p>  <p>PFAFF 1181/1183 2081/2083</p> <p>φ 7.94</p>	<p>KHS11S-58</p>  <p>JUKI LZ-581~586</p> <p>φ 7.24</p>	<p>KHS271-S</p>  <p>DURKOPP/ADLER 271</p> <p>φ 7.24</p>
<p>KHS30-RPNG</p>  <p>BROTHER BAS-300G-484/SF BAS-326H-484/-484SF KE-484C-X LK3-B484, KE-484C</p> <p>φ 7.94</p>	<p>KHS367-SP</p>  <p>DURKOPP/ADLER 367</p> <p>φ 8</p>	<p>KHS438</p>  <p>PFAFF 437~439</p> <p>φ 7.24</p>
<p>KHS480</p>  <p>(KHS480+SC39) PFAFF 461~469 461-900~469-900 481-900~489-900</p> <p>φ 7.24</p> <p>※Hook, Bobin case are sold separately.</p>		

Teflon HOOK BASE TEFLON















DLC HOOK BASE DLC COATING MINIMAL OIL

Ti HOOK BASE TITANIUM COATING

ADJ ADJUSTABLE STRONG NEEDLE GUARD

N WITH NON SLIP SPRING

* = EXCLUSIVE ITEMS

ROTARY HOOK LOW SPEED TYPE: KR		
<p>KR134</p>  <p>PFAFF 133/134</p> <p>φ 7.24</p>	<p>KR18</p>  <p>SINGER 188U 195K, 196K</p> <p>φ 7.24</p>	<p>KR21-G</p>  <p>JANOME TA-J761/-J763/-J766 SINGER 95-40/96-40</p> <p>φ 7.24</p>
<p>KR21-GTPDE</p>  <p>SUNSTAR KM-380 YAKUMO 380/380B/380Y</p> <p>φ 7.24</p>	<p>KR21-R</p>  <p>BROTHER DB1-B760-5, -B767/-5 GOLDEN WHEEL CS-350 MITSUBISHI CU-865-12 DB-320-12/-325 SINGER 95-40/96-40</p> <p>φ 7.24</p>	<p>KR21-RD</p>  <p>MITSUBISHI DN-350-12/-352</p> <p>φ 7.24</p>
<p>KR21-RPDE</p>  <p>YAKUMO 380/380B/380Y</p> <p>φ 7.24</p>	<p>KR21-S</p>  <p>DURKOPP/ADLER 96 206/207/270 GOLDEN WHEEL CS-3600, -8000-20 MITSUBISHI DB-320-10 DX-370 LX2-371-MO SINGER 95-40/96-40</p> <p>φ 7.24</p>	<p>KR23-16</p>  <p>CONSEW 722/825 DURKOPP/ADLER 199/289/489 JUKI LZ-391, -391N</p> <p>φ 7.24</p>
<p>KR238</p>  <p>PFAFF 238 TAKING TK-735/-735N</p> <p>φ 7.24</p>	<p>KR238-14</p>  <p>PFAFF 130 138</p> <p>φ 7.24</p>	<p>KR24</p>  <p>BROTHER LE2-B861-1 SUNSTAR KLZ-371 TYPICAL GG1-1/-2 UNICORN LZ2-H272</p> <p>φ 7.24</p>
<p>KR24-B</p>  <p>BROTHER LE2-B861-7 TZ1-B651/-B652 GOLDEN WHEEL CS-335BH/-335U JUMBO KING WR-652 MILLION SPECIAL MS-652/-B652 UNICORN TZ1-B652</p> <p>φ 7.24</p>	<p>KR24-RHPD</p>  <p>JUMBO KING WR-335A/ -335B/-3358B/ -3358BL/-335-901</p> <p>φ 7.24</p>	<p>KR24-U</p>  <p>SINGER 20U11/13/23</p> <p>φ 7.24</p>

Teflon 特氟隆内釜







DLC 像鑽石一樣堅硬的石炭塗層内釜

Ti 鈦塗層

ADJ 护针片調整旋梭

N 附防止空軋彈簧片

* = EXCLUSIVE ITEMS

ROTARY HOOK LOW SPEED TYPE: KR		
<p>KR24U-31</p>  <p>SINGER 20U31</p> <p>φ 7.24</p>	<p>KR24U-42</p>  <p>GOLDEN WHEEL CS-2180 MILLION SPECIAL MS-20U SINGER 20U142 20U42/43, 20UX143 ZOJE ZJ20U23/33/43/53/63</p> <p>φ 7.24</p>	<p>KR24U-42S</p>  <p>SINGER 20U31/33/34</p> <p>φ 7.24</p>
<p>KR335-V</p>  <p>(KR335-V+SC335-V) GOLDEN WHEEL CS-335L PFAFF 335G</p> <p>φ 7.24</p> <p>※Hook, Bobin case are sold separately.</p>	<p>KR69</p>  <p>DURKOPP/ADLER 69-373 GOLDEN WHEEL CS-8753L/-8753LV</p> <p>φ 7.24</p>	<p>KR69-V</p>  <p>CONSEW 277R GOLDEN WHEEL CS-2280 SEIKO LSC-8B, -8BV-1, -8B-2, -8BV-2 TYPICAL WANPING TW3-335/-335V</p> <p>φ 7.24</p>
<p>KR69-VP</p>  <p>SEIKO HC-2B</p> <p>φ 7.24</p>		

Teflon HOOK BASE TEFLON















DLC HOOK BASE DLC COATING MINIMAL OIL

Ti HOOK BASE TITANIUM COATING

ADJ ADJUSTABLE STRONG NEEDLE GUARD

N WITH NON SLIP SPRING

* = EXCLUSIVE ITEMS

ROTARY HOOK HIGH SPEED ZIGZAG TYPE: KRP		
<p>KRP41-B</p>  <p>BROTHER LH4-B814/-2/-3/-4</p> <p>φ 7.93</p>	<p>KRP41-LH</p>  <p>GOLDEN WHEEL CSH-7830 JUKI LBH-761, -762, -763 SHANGGONG G15</p> <p>φ 7.94</p>	<p>KRP41-LH2</p>  <p>GOLDEN WHEEL CSH-7800 JACK JK-781 K-CHANCE KBH-780 MAQI LS7810301 JUKI LBH-771~773, 781 ~784</p> <p>φ 7.94</p>
<p>KRP41-LH3ICC DLC</p>  <p>CHNKI CBH-1790 JACK JK-T1790 MAQI LS-T1790B/-T1790S SIRUBA LBHS-1790S ZOJE ZJ5780BS, ZJ5781DS</p> <p>φ 7.94</p>	<p>KRP41-LH3KICC DLC</p>  <p>JACK JK-T1790S-0416 SIRUBA BH790B LBHS-1792K(FOR KNITS)</p> <p>φ 7.94</p>	<p>KRP41-R</p>  <p>BROTHER DL1-B812/-B813 LZ1-B851 SINGER 107G 107U202 107W1/3/5/17</p> <p>φ 7.93</p>
<p>KRP41-S</p>  <p>DURKOPP/ADLER 91/98/252/253/254/ 255/264 SINGER 107G 107U202 107W1/3/5/17 143W1 SUNSTAR DPK-2/-3</p> <p>φ 7.93</p>	<p>KRP457</p>  <p>BROTHER LZ2-B852/-B853/-B854 JACK JK-457 MITSUBISHI LZ-720/-780/-790 SINGER 457A/U ZOJE ZJ457A/457B/457D</p> <p>φ 7.94</p>	<p>KRP457JICC DLC</p>  <p>GOLDEN WHEEL CS-2380/-2383 HIGHLEAD GC0068-1/-1D</p> <p>φ 7.94</p>
<p>KRP457JTI Ti</p>  <p>MAQI PF22841114 SUNSTAR KM-2070/-2070P UNICORN TZ-H2100 ZOJE ZJ2290/2293</p> <p>φ 7.94</p>	<p>KRP457-W</p>  <p>SINGER 457G STAGER SZ-310 SERIES</p> <p>φ 7.94</p>	<p>KRP457-W3ICC DLC</p>  <p>SINGER 457A 457G 457U</p> <p>φ 7.94</p>
<p>KRP800BTI Ti</p>  <p>BROTHER HE-800A/-800B/-800C SUNSTAR BH/3000/3100</p> <p>φ 7.94</p>	<p>KRP818</p>  <p>BROTHER HM-8180</p> <p>φ 7.94</p>	<p>KRP856TI Ti</p>  <p>BROTHER Z-series, ZE-series SUNSTAR KM-2077</p> <p>φ 7.94</p>

Teflon 特氟隆內釜















DLC 像鑽石一樣堅硬的石炭塗層內釜

Ti 鈦塗層

ADJ 护針片調整旋梭

N 附防止空轉彈簧片

* = EXCLUSIVE ITEMS

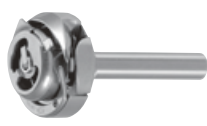
ROTARY HOOK STANDARD TYPE WITH SHAFT: KRT		
KRT11-5  CONSEW 139/224/225/226/ 237/239 SEIKO STW-6, -7, -7B, -8, -8BV, -8V SINGER 211W151/155 φ9.52	KRT12-4  SINGER 112W140/145/146 φ7.94	KRT12-5B  CONSEW 332 GOLDEN WHEEL CS-3101 MAQI LS2052100701 SEIKO LTW-26,-27, -27B, -27BM φ9.52
KRT12-5BF  BROTHER LT2-B831/-3,-B832- 1/3,-B833 SICAMA LT2-B842 SUNSTAR KM-740, -750 φ9.52	KRT12-5JCI  JUKI LH-1152-4/-5/-6 φ9.52	KRT12-5JI  JUKI LH-1150 LH-1152 φ9.52
KRT12-5M  HIGHLEAD GC20518-M MITSUBISHI DB-286 DN-260/-7 LT2-2220-MOB SINGER 211A, 212A141BA/GA TYPICAL GC20201 φ9.52	KRT30JCI  JUKI LH-3128-7, -3168-7 φ9.52	KRT842CI  BROTHER LT2-B842/-B842-403/ -405/-903/-905 LT2-B847-401/-901 T-8422A-403/-405/-433 TL-847B TN-842B-403/-405 SUNSTAR KM-1750/1751 φ9.52
KRT842F-S  BROTHER LT2-B841-3/-B842-3 LT2-B847-1 T-8420A TN-842A-003/-00F JACK JK-58420-003, -5842-3/D-3 JUKI LH-3120A/AF, -3128 ZOJE ZJ842 φ9.52	KRT842H-S  BROTHER LT2-B841-5/-B842-5 T-8420A-005/ -8420B-005 T-8421A-T05 TN-842A-005 JACK JK-58420-005, -5842-5/ D-5 ZOJE ZJ842-5 φ9.52	SKRT12-5-19R (KRT12-5-19R+SCP18)  GOLDEN WHEEL CSL-1720 φ9.52
SKRT12-5BK (KRT12-5BK+SCP-BK)  CONSEW 327R-1 GOLDEN WHEEL CS-3150/-3/-5, 875-3/-5 SEIKO LTW-27BK SICAMA LT2-B845 φ9.52	SKRT12-5MK (KRT12-5MK+SCP-MK)  HIGHLEAD GC20528-M MITSUBISHI DN-275-10 LT2-2240-MOB SINGER 212A143 TYPICAL GC6240M UNICORN LT2-H625(M) φ9.52	SKRT842C (KRT842KC+SCP-842BC)  BROTHER LT2-B847-401/-901 T-8422A-403 TN-842B-40F JACK JK-58420D/-005 φ9.52

Teflon HOOK BASE TEFLON

DLC HOOK BASE DLC COATING
MINIMAL OIL

Ti HOOK BASE
TITANIUM COATING

ADJ ADJUSTABLE STRONG
NEEDLE GUARD

N WITH NON SLIP SPRING

* = EXCLUSIVE ITEMS

ROTARY HOOK LARGE TYPE WITH SHAFT: KRT

<p>KRT11-5LJR</p>  <p>GOLDEN WHEEL CS3L-7243 JUKI LU-1508H/NH LU-563-3 SINGER 212U539A/839A TYPICAL GC20665</p> <p>φ 9.52</p>	<p>KRT11-5LJS</p>  <p>JUKI LU-1510/N, -1560/N LU-562N, -563N TYPICAL WANPING GC20665</p> <p>φ 9.52</p>	<p>KRT11-5LLJCI-R</p>  <p>JUKI LU-1114-4/-5/-6/-7</p> <p>φ 9.52</p>
<p>KRT12-5LM</p>  <p>mitsubishi DN-260-22/-262 LT2-2220-BOB SUNSTAR KM-740BL TYPICAL GC20202 TYPICAL WANPING GC20606 UNICORN LS2-H620(H)</p> <p>φ 9.52</p>	<p>KRT12-5LMC</p>  <p>HIGHLEAD GC20618-1/-2, 20698-1/-2 MITSUBISHI DN-125-22 LU2-4420-BOB</p> <p>φ 9.52</p>	<p>KRT12-5LMC-R</p>  <p>GOLDEN WHEEL CSU-4150/-4250</p> <p>φ 9.52</p>
<p>KRT12-5LMKC-CI</p>  <p>HIGHLEAD GC20698-1D/-2D MITSUBISHI CS-4150BT LU2-4730-B1T UNICORN LT2-H6500</p> <p>φ 9.52</p>	<p>KRT12-5LMKCI</p>  <p>HIGHLEAD GC20568-BDZ MITSUBISHI LT2-2230-B1T TYPICAL GC6220BD UNICORN LT2-H6200(H)</p> <p>φ 9.52</p>	<p>KRT872L</p>  <p>BROTHER LT2-B872-3/5 T-8720A-003/-005 TN-872A-003/-005 JACK JK-58720-003/-005 JUKI LH-3178, -3188 SIRUBA T828-72 SERIES</p> <p>φ 9.52</p>
<p>KRT8-LCI2-S</p>  <p>SEIKO LLW-28BLC/CS LLW-8BLC/CS LSW-8BLC-CS1</p> <p>φ 9.52</p>	<p>KRT8-LCR-CS</p>  <p>SEIKO LLW-8BL/CS LSW-8BL/CS LSWN-8BL, -8BLV LSWNH-8BL-20-1 SERIES</p> <p>φ 9.52</p>	<p>KRT8-LCS-CS</p>  <p>SEIKO LLW-28BL/CS LLWN-8BL/CS LSW-8BL/CS, -28BL/ CS LSWNH-28BL-20-1 SERIES</p> <p>φ 9.52</p>
<p>KRT-LS2CI-S</p>  <p>BROTHER LT2-B837-300 SUNSTAR KM-560-7 TOYOTA AD3110/3310/3320</p> <p>φ 9.52</p>	<p>KRT-LS2R</p>  <p>BROTHER LT2-B837/-5 PRINCE PLM-100</p> <p>φ 9.52</p>	<p>KRT-LSR</p>  <p>CONSEW 244/254B/255 SEIKO LLW-8BL LSW-26BL LSW-7BL LSW-8BLV, -8BLM SINGER 212A939JA/JB SUNSTAR KM-570BL/-572BL</p> <p>φ 9.52</p>

Teflon HOOK BASE TEFLON





DLC HOOK BASE DLC COATING
MINIMAL OIL

Ti HOOK BASE
TITANIUM COATING

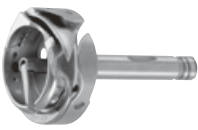

ADJ ADJUSTABLE STRONG
NEEDLE GUARD

N WITH NON SLIP SPRING

* = EXCLUSIVE ITEMS

ROTARY HOOK LARGE TYPE WITH SHAFT: KRT		
<p>KRT-LSRB</p>  <p>SEIKO LLW-28BL-TA, -28L-TA LLWH-28BL-TA LSW-28BL-TA</p> <p>φ 9.52</p>	<p>KRT-LSS</p>  <p>CONSEW 333/339 SEIKO LLW-28, -28BL LSW-27L, -28L</p> <p>φ 9.52</p>	<p>SKRT11-5LJKS</p>  <p>(KRT11-5LJKS+SCP-LJK) JUKI LH-527 LU-1565N LUH-526</p> <p>φ 9.52</p>
<p>SKRT12-5LMK</p>  <p>(KRT12-5LMK+SCP-LMK) HIGHLEAD GC20518-B,20528-B MAQI LS2252H100701 MITSUBISHI LT2-2240-BOB PLY-501F TYPICAL GC6240B UNICORN LT2-H625(H)</p> <p>φ 9.52</p>	<p>SKRT872LC</p>  <p>(KRT875LC+SCP-LBC) BROTHER LT2-B872 T-8722A-403/-405 JACK JK-58720D/-003 TYPICAL GC9720M/9720HD3 TYPICAL WANPING TW2-B872-905 ZOJE 872-D3</p> <p>φ 9.52</p>	<p>SKRT875LKC</p>  <p>(KRT875LC+SCP-LBKC) BROTHER LT2-B875 T-8752A-403/-405 JACK JK-58750D-003 MAQI PF8750D30849 SUNSTAR KM-1790BL ZOJE 875-D3</p> <p>φ 9.52</p>

* = EXCLUSIVE ITEMS

ROTARY HOOK STANDARD TYPE WITHOUT SHAFT: KRT		
<p>KRT190</p>  <p>MITSUBISHI DX-870</p> <p>φ 7.93</p>	<p>KRT21</p>  <p>JUKI LH-512, -515 SINGER 212G140/141/145/440 212GX4/5/6 212LX670 212U41/141/442 212W140/145/146</p> <p>φ 8.01</p>	<p>KRT21-R</p>  <p>JUKI LH-512H, -515H</p> <p>φ 8.01</p>
<p>KRT31-11R</p>  <p>SINGER 131W 153K, 153W 21W180/182 46W 52W30/31</p> <p>φ 7.93</p>	<p>KRT31-11S</p>  <p>CONSEW 207/223/227 382/388/389 SEIKO CW SERIES SINGER 131W 47W70 TYPICAL WANPING TW3-8B</p> <p>φ 7.93</p>	<p>KRT31-11SG</p>  <p>GLOBAL LP9915L/R, WF-975 HIGHLEAD GC22618 GC24698-1L/-1R JUKI LS-1340</p> <p>φ 7.93</p>
<p>KRT31-NR</p>  <p>GOLDEN WHEEL CS-810/-820/-821/-822 JUMBO KING WR-810/-820/-830 WR-830P/-840/-840P MILLION SPECIAL MS-810/-820</p> <p>φ 7.93</p>	<p>KRT31-R</p>  <p>GOLDEN WHEEL CS-3610 SINGER 131W SUNSTAR KM-815C/-825C/ -857/-867 TAKING TK-810</p> <p>φ 7.93</p>	<p>KRT31-RG</p>  <p>SEIKO LPW-6, -6B, -7, -7B, -8, -8B PW-26B/-1, -27B, -28B PW-6/-1, -7, -7B</p> <p>φ 7.93</p>
<p>KRT412-S</p>  <p>SINGER 412U141/141G</p> <p>φ 7.93</p>	<p>KRT67</p>  <p>DURKOPP/ADLER 67/68</p> <p>φ 7.93</p>	<p>SKRT190G</p>  <p>(KRT190G+SCPF19) MITSUBISHI LX5-871-MO PAFF 190</p> <p>φ 7.93</p>
<p>SKRT31MIN</p>  <p>(KRT31MIN+SCP31MIN) GOLDEN WHEEL CS-8381S/-8382S, -8369MHS/MHSR/MS/MSR/S/SR</p> <p>φ 7.93</p>	<p>SKRT31-SKG</p>  <p>(KRT31-SKG+SCP31-K) SEIKO LPW-27BK</p> <p>φ 7.93</p>	<p>SKRT390-HBG</p>  <p>(KRT390-HBG+SCPF15H) GOLDEN WHEEL CS-8365/-8365M/-8365H/ -8366/ -8366M CS-8367/-8367M/ -8368/-8900/ -8901/-8902</p> <p>φ 7.93</p>

Teflon HOOK BASE TEFLON







DLC HOOK BASE DLC COATING MINIMAL OIL

Ti HOOK BASE TITANIUM COATING









ADJ ADJUSTABLE STRONG NEEDLE GUARD

N WITH NON SLIP SPRING

* = EXCLUSIVE ITEMS

ROTARY HOOK STANDARD TYPE WITHOUT SHAFT: KRT		
<p>SKRT470C2-R</p> <p>(KRT470C2-R+SCPF441)</p>  <p>JUMBO KING WR-981 SERIES WR-9910-BT WR-991-T/-TS WR-9920-BT WR-992-T/-TS</p> <p>φ 7.93</p>	<p>SKRT470C-R</p> <p>(KRT470C-R+SCPF441)</p>  <p>GOLDEN WHEEL CS-6111BFT MILLION SPECIAL MS-474-510/-530 MS-491-810/-830 SUNSTAR KM-857-7/-867-7 KM-957-7/-967-7 TAKING TK-591T/-591TB</p> <p>φ 7.93</p>	<p>SKRT470-RH</p> <p>(KRT470-RH+SCPF15H)</p>  <p>GOLDEN WHEEL CS-8360/-8361/ -8362 SEIKO LHPW-8B-1 LHPW-8B-1-SF-LP LHPWN-8B-3-SF-LP LHPWN-8B-3-TA-SF-LP</p> <p>φ 7.93</p>
<p>SKRT470-R</p> <p>(KRT470-R+SCPF15)</p>  <p>GOLDEN WHEEL JUMBO KING MILLION SPECIAL PFAFF SUNSTAR</p> <p>φ 7.93</p>	<p>CS-8381/-8381R/-8382/-8810/ -8812/-8813/ -8820 WR-991/-992 WR-9910-B/-9920-B MS-474-500 MS-491-800 471 ~ 493 KM-957/-967</p>	<p>SKRT470-RHB</p> <p>(KRT470-RHB+SCPF15H)</p>  <p>GOLDEN WHEEL CS-8810H/-8820H</p> <p>φ 7.93</p>
<p>SKRT47MIN</p> <p>(KRT47MIN+SCP31MIN)</p>  <p>JUMBO KING WR-998-244-S/-CS/ -DS</p> <p>φ 7.93</p>	<p>SKRT592V2-R</p> <p>(KRT592V2-R+SCPF572)</p>  <p>BAIPU GOLDEN WHEEL JACK PFAFF TTY ZOJE</p> <p>φ 7.93</p>	<p>ADJ</p> <p>BP-1574H/-1591 CS-8830-A JK-6691/-6692 571/574/591/1571/1574/1591 TTY-91218, -9618, -9922 ZJ9610/9620</p>

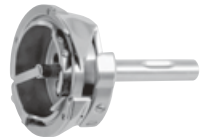
* = EXCLUSIVE ITEMS

ROTARY HOOK SPECIAL TYPE: KRT		
<p>KRT132</p>  <p>DURKOPP/ADLER 265 GOLDEN WHEEL CS-6500/-6501 MITSUBISHI DY-253/-253-00 SEIKO SK-2B,-6,-6F,-7 SINGER 132K</p> <p>φ 10.3</p>	<p>KRT132-M</p>  <p>SEIKO SKM-26,-36</p> <p>φ 10.3</p>	<p>KRT132-MT</p>  <p>GOLDEN WHEEL CSL-1810</p> <p>φ 10.3</p>
<p>KRT132-SKZ</p>  <p>SEIKO SKZ SERIES</p> <p>φ 10.3</p>	<p>KRT133</p>  <p>SEIKO CK-1 SINGER 133K</p> <p>φ 10.3</p>	<p>KRT14-5</p>  <p>DURKOPP/ADLER 220 GLOBAL WF-9201-50/-9202-50 HIGHLEAD GC20698-5/-5T/-6/-6T SINGER 144W, 145W</p> <p>φ 10</p>
<p>KRT14-5HP</p>  <p>CUEY FENG GF204-221/221-205 JUKI LG-57, -158/-1, LG-158-1U, -158U SINGER 144W, 145W</p> <p>φ 9.52</p> <p>Hard Hook Point</p>	<p>KRT14-5-O</p>  <p>CONSEW 744R/745R SEIKO JW-28BL-20 TYPICAL TW1-28BL</p> <p>φ 9.52</p>	

Teflon HOOK BASE TEFLON





DLC HOOK BASE DLC COATING MINIMAL OIL

Ti HOOK BASE TITANIUM COATING















ADJ ADJUSTABLE STRONG NEEDLE GUARD

N WITH NON SLIP SPRING

* = EXCLUSIVE ITEMS

SHUTTLE HOOK MISCELLANEOUS PARTS: KSP		
KSP204	KSP204N	KSP7-9
 <p> CHIKON CK-1461 CONSEW 757 DURKOPP/ADLER 204/205 JUMBO KING WR-204 SEIKO CH-2B, -6B, -7B TH-6B, -8B </p>	 <p> CHIKON CK-243/-273/-441 GOLDEN WHEEL CS-243/-273/-441 JUKI TNU-243U TSH-411U, -421U TU-273U JUMBO KING WR-204-370/-205 </p>	 <p> SINGER 7-9 </p>
<p>KSP7-31</p>  <p> HIGHLEAD GA1398-1 SEIKO SLH-2B/-1/FH-1 TYPICAL WANPING 733R </p>		

* = EXCLUSIVE ITEMS

ROTARY HOOK LARGE TYPE WITHOUT SHAFT: KRT		
<p>KRT170LJCI-S</p>  <p>JUKI PLC-1710-7, -1760-7</p> <p>φ 7.94</p>	<p>KRT170LJI-S</p>  <p>JUKI PLC-1710, -1760</p> <p>φ 7.94</p>	<p>KRT211-L</p>  <p>SINGER 212G539/541 212GX106/114 212U541A/841A</p> <p>φ 7.93</p>
<p>KRT26-LPC2</p>  <p>SEIKO LPWN-28BLC, -8BLC</p> <p>φ 10</p>	<p>KRT31-LR</p>  <p>GOLDEN WHEEL CS-5371A/-5371N/ -5372N/-7375 CS-8330/-8331/ -8350/-8903/-8907/ -8908/-8908N</p> <p>φ 7.93</p>	<p>KRT467J ADJ</p>  <p>GOLDEN WHEEL CS-8681 JUKI LU-2200 SERIES</p> <p>φ 7.94</p>
<p>KRT467L</p>  <p>SEIKO BEW SERIES</p> <p>φ 10</p>	<p>KRT467XLI-R ADJ</p>  <p>DURKOPP/ADLER 467 XXL/767 XXL</p> <p>φ 10</p>	<p>KRT470LCI-R</p>  <p>JUMBO KING WR-991-X2TS</p> <p>φ 7.93</p>
<p>KRT768I-ICC-R DLC</p>  <p>DURKOPP/ADLER 768</p> <p>φ 7.94</p>	<p>KRT867XLI-R ADJ</p>  <p>DURKOPP/ADLER 867 XXL/1767 XXL</p> <p>φ 8</p>	<p>KRT8-BL</p>  <p>GOLDEN WHEEL CS-8BL/-8BLV SEIKO LCW-8BL/-1 LCWN-8BL SUNSTAR KM-390BL</p> <p>φ 7.93</p>
<p>KRT8-LPR</p>  <p>SEIKO BBWP-8BL/-BTFL LPW-6L, -6BL, -7L LPWN-8BL TYPICAL GC24690</p> <p>φ 10</p>	<p>KRT8-LPS</p>  <p>HIGHLEAD GC24896-2B SEIKO BBWP-28BL/-BTFL LPW-26L, -26BL LPWN-28BL, -28L LW-27L</p> <p>φ 10</p>	<p>SKRT1242-R</p>  <p>(KRT1242-R+SCP545) PFAFF 1241~1246 1242-720 1242-748 TYPICAL WANPING 1245 TW1-1245</p> <p>φ 7.93</p>

Teflon HOOK BASE TEFLON

DLC HOOK BASE DLC COATING
MINIMAL OIL





Ti HOOK BASE
TITANIUM COATING

ADJ ADJUSTABLE STRONG
NEEDLE GUARD

N WITH NON SLIP SPRING

* = EXCLUSIVE ITEMS

ROTARY HOOK LARGE TYPE WITHOUT SHAFT: KRT

SKRT341G	SKRT341-NR	SKRT545G
<p>(KRT341G + SCP545)</p>  <p>GOLDEN WHEEL CS-8233/-NR HIGHLEAD GC22618-1B JUKI LS-321 JUMBO KING WR-341 MILLION SPECIAL MS-1341</p> <p>φ 7.94</p>	<p>(KRT341-NR+SCP545)</p>  <p>GOLDEN WHEEL CS-8243/-8243D JUKI LS-1341 MITSUBISHI LU3-6860 SEWSTAR CW-269 TYPICAL WANPING TW3-341</p> <p>φ 7.94</p>	<p>(KRT545G+SCP545)</p>  <p>TAKING TK-551</p> <p>φ 7.93</p>
<p>SKRT8-LPK</p> <p>(KRT8-LPK+SCP-BLP)</p>  <p>GLOBAL LP-9226-LH/SNB HIGHLEAD GC24628-1 SEIKO LPW-27BLK, -28BLK</p> <p>φ 10</p>		

Teflon 特氟隆内釜















DLC 像鑽石一樣堅硬的石炭塗層内釜

Ti 鈦塗層

ADJ 护针片调整旋梭

N 附防止空轉彈簧片

* = EXCLUSIVE ITEMS

SHUTTLE HOOK: SH					
SH181	 MITSUBISHI PLK-G SERIES UNICORN UAS-H1407(M)	SH181H	 MITSUBISHI PLK-G SERIES UNICORN UAS-H1407(H)	SH232	 JUKI LK-232
SH280	 JACK JK-1900 SERIES JUKI LK-1900 SERIES LK-280, 980 SIRUBA LKS-1900 SERIES SUNSTAR SPS/C-B1201K/L/M ZOJE ZJ1900 SERIES	SH280Ti	 JUKI LK-1850/C, -1851/C	SH282	 JACK JK-1900 SERIES JUKI LK-1900 SERIES LK-282 SIRUBA LKS-1900 SERIES SUNSTAR SPS/C-B1201H ZOJE ZJ1900HS SERIES
SH31	 SINGER 31-15 431D200A	SH311A	 BROTHER BAS-300, -311, -326 KE-434C-1 SewTech ST-N3020B	SH311B	 BROTHER BAS-300, -311, -326 KE-434C-2/-435-C
$\phi 8$				$\phi 10$	
SH430	 BROTHER BE-438FX II KE-430 SERIES LK3-B4300 SERIES	SH430-H	 BROTHER BE-438FX II KE-430 SERIES LK3-B4300 SERIES	SH469	 SINGER 469U 569U
SH51	 SINGER 71	SH570	 DURKOPP/ADLER 570	SH61	 SINGER 269W

Teflon HOOK BASE TEFLON





DLC HOOK BASE DLC COATING
MINIMAL OIL

Ti HOOK BASE
TITANIUM COATING

ADJ ADJUSTABLE STRONG
NEEDLE GUARD















N WITH NON SLIP SPRING

* = EXCLUSIVE ITEMS

SHUTTLE HOOK: SH		
SH61CR	SH61-NG	SH-P1
 <p>SINGER 269W</p>	 <p>BROTHER LK3-B220/-B221/ -B222/-B223/-B826/ -B827/-B828</p>	 <p>PFAFF 3125A/B 3135A/B 3136A/B 3331A/B 3334~3337A/B</p>
<p>SH-P2</p>  <p>PFAFF 3125C 3135C 3136C 3331C 3334~3337A/B</p>		

* = EXCLUSIVE ITEMS

CAP : SCP

CAP : SCP		
<p>SCP31MIN</p>  <p>GOLDEN WHEEL CS-8381S/-8382S, -83 69MHS/MHSR/ MS/ MSR/ S/ SR JUMBO KING WR-998-244-S/-CS/ -DS</p>	<p>SCP545</p>  <p>GOLDEN WHEEL CS-8243/-8243D/ -8244L/-8244L1-K JUKI LS-1341 JUMBO KING WR-341 MILLION SPECIAL MS-1245 PFAFF 1241~1246</p>	<p>SCP-842BC</p>  <p>BROTHER LT2-B847-401/-901 T-8422C-403/-433 TN-842B-40F JACK JK-58420D/-005 JUKI LH-3128</p>
<p>SCP-842BK</p>  <p>BROTHER LT2-B845/-3/-5/-7 T-8450A-003/-005 TL-848A TN-845A-003/-005 JACK JK-58450-003/-005 JUKI LH-3168/-7 SUNSTAR KM-790</p>	<p>SCP-842BKC</p>  <p>BROTHER LT2-B845-403/-405 T-8452A-403/-405 TL-848B JACK JK-58450D/-003/ -005 SUNSTAR KM-1790/-1791</p>	<p>SCP-BK</p>  <p>CONSEW 327R-1 GOLDEN WHEEL CS-3150/-3/-5, 875- 3/-5 SEIKO LTW-27BK</p>
<p>SCP-BLP</p>  <p>GLOBAL LP-9226-LH/SNB HIGHLEAD GC24628-1 SEIKO LPW-27BLK, -28BLK</p>	<p>SCPF15</p>  <p>GOLDEN WHEEL CS-8810 JUMBO KING WR-9910-B/-9920-B MILLION SPECIAL MS-474-500 PFAFF 471~493 SEIKO PWB-8GW-1</p>	<p>SCPF15H</p>  <p>GOLDEN WHEEL CS-8360/-8361/ -8362 CS-8810H/-8820H SEIKO LHPW-8B-1 LHPW-8B-1-SF-LP LHPWN-8B-3-SF-LP LHPWN-8B-3-TA-SF-LP</p>
<p>SCPF441</p>  <p>GOLDEN WHEEL CS-6111BFT JUMBO KING WR-9910-BT WR-9920-BT MILLION SPECIAL MS-474-510/-530 SUNSTAR KM-857-7/-867-7 UNICORN LT5-H7200/-H7600</p>	<p>SCPF572</p>  <p>BAIPU BP-1574H/-1591 JACK JK-6691/-6692 PFAFF 571/574/591 TTY TTY-91218 ZOJE ZJ9610/9620</p>	<p>SCP-LBC</p>  <p>BROTHER LT2-B872-403/405 T-8722A-403/-405 JACK JK-58720D/-003/-005 TYPICAL GC6872MD3 TYPICAL WANPING TW2-B872-905 ZOJE 872-D3</p>
<p>SCP-LBKC</p>  <p>BROTHER LT2-B875/-403 T-8752A-403/-405 JACK JK-58750D TYPICAL GC6875HD3/6875MD3 TYPICAL WANPING TW2-B875-905 ZOJE 875-D3</p>	<p>SCP-LMK</p>  <p>HIGHLEAD GC20518-B, 20528-B MILLION SPECIAL MS-B875/-B875-5 MITSUBISHI LT2-2240-BOB PLY-501F TYPICAL GC6240B UNICORN LT2-H625(H)</p>	<p>SCP-MK</p>  <p>HIGHLEAD GC20528-M MITSUBISHI LT2-2240-MOB LT2-240-MOB SINGER 212A143 TYPICAL GC6240M UNICORN LT2-H625(M)</p>

Teflon HOOK BASE TEFLON















DLC HOOK BASE DLC COATING
MINIMAL OIL

Ti HOOK BASE
TITANIUM COATING

ADJ ADJUSTABLE STRONG
NEEDLE GUARD

N WITH NON SLIP SPRING

* = EXCLUSIVE ITEMS

BOBBIN CASE STANDARD TYPE: SC		
<p>SC31</p>  <p>BROTHER DB1-B760-5 SL-1010-3/-1110-2 DURKOPP/ADLER 96 JACK JK-8500 JUKI DDL-8100E, -8700 ZOJE ZJ9503/9600</p>	<p>SC31-NS N</p>  <p>BROTHER S-7200A-403/-433 JACK A4, A5 JUKI DDL-8000AP-MS DDL-9000 SERIES ZOJE ZJ8850-5-D3</p>	<p>SC33</p>  <p>CONSEW 205RBH</p>
<p>SC33-NS N</p>  <p>DURKOPP/ADLER 271</p>	<p>SC34-1</p>  <p>JUMBO KING WR-335A/-335B/ -3358B/-3358BL WR-652 TAKING TK-335/-335N TK-652</p>	<p>SC34-2NS N</p>  <p>FOR EMBROIDERY</p>
<p>SC35</p>  <p>BROTHER LE2-B861-1 GOLDEN WHEEL CS-335BH/-335U JUKI LZ-391, -391N JUMBO KING WR-652-901 MILLION SPECIAL MS-20U143</p>	<p>SC35-NS N</p>  <p>FOR EMBROIDERY</p>	<p>SC35-T</p>  <p>CONSEW 722/825 DURKOPP/ADLER 199/289/489 GOLDEN WHEEL CS-2180 SINGER 20U11/13/23 20U142 20U31</p>
<p>SC39</p>  <p>DURKOPP/ADLER 69-373 GOLDEN WHEEL CS-8753L/-8753LV PFAFF 130 437~439 481-900~489-900</p>	<p>SC39-14</p>  <p>CONSEW 277R GOLDEN WHEEL CS-2280 PFAFF 130, 138 SEIKO LSC-8B, LSC-8BV-1, -8BV-2 TYPICAL WANPING TW3-335/-335V</p>	<p>SC39-14NS N</p>  <p>SEIKO HC-2B LSC-8BHC/-BT</p>
<p>SC39-NS N</p>  <p>SEIKO HC-2B</p>	<p>SC81-2</p>  <p>SUNSTAR KM-380</p>	<p>SC81-2NS2 N</p>  <p>GOLDEN WHEEL CS-8703-BT JUKI DSC-244/-4/-6, -244V/-4/-6</p>

Teflon 特氟隆内釜

DLC 像鑽石一樣堅硬的石炭塗層内釜



Ti 鈦塗層

ADJ 护针片調整旋梭















N 附防止空轉彈簧片

* = EXCLUSIVE ITEMS

BOBBIN CASE STANDARD TYPE: SC

SC82-J	SC82-JNS N	SC82-JNS2 N
 <p> GLOBAL NF-331/-SK HIGHLEAD GC0518/-H/-MC SUNSTAR KM-350A KM-350B KM-530/-530-7 TYPICAL GC6-10/-11 GC6160 </p>	 <p> JUKI DDL-555H-4-5, -5580H MITSUBISHI LS2-2210-M PFAFF 1181/1183 2081/2083 SUNSTAR KM-350A-7 ZOJE ZJ2628 </p>	 <p> BEYOUNG BM-244/-244V JUKI DSC-244/-4/-6, -244V/-4/-6 DSC-245-4/-5/-6 </p>

* = EXCLUSIVE ITEMS

BOBBIN CASE LARGE TYPE: SC		
<p>SC31-L</p>  <p>JUKI DU-1181N/-**A</p>	<p>SC33-L</p>  <p>JACK JK-6318 JUKI DSC-246-4/-6 MITSUBISHI LY2-3300-BOB ZOJE ZJ8500H</p>	<p>SC33-LB N</p>  <p>TYPICAL GC6-9-D2</p>
<p>SC33-LD N</p>  <p>CONSEW 206RB/306RB JUKI DNU-1541-7 DSC-246/-4/-6 SEIKO STH SERIES SUNSTAR KM-590B/-591BL TYPICAL WANPING GC3002CX</p>	<p>SC33-LDH N</p>  <p>GOLDEN WHEEL CS-8113/-8713/ -8713-V</p>	<p>SC33-LNS N</p>  <p>BROTHER SN-7230-5/-7240-5 JACK JK-6380D JUKI DDL-5600NJ/NU/NL MITSUBISHI PLK-G**R SERIES SEIKO H-2B,-2BL</p>
<p>SC33-LNS3 N</p>  <p>JUKI DSC-246/-4/-6 DSU-144, -145 SEIKO HC-2BL/-1 LSC-8BL TYPICAL WANPING TW3-S336VB</p>	<p>SC33-LNSH N</p>  <p>GOLDEN WHEEL CS-6210/-6220</p>	<p>SC34-L</p>  <p>CONSEW 175/175RB GOLDEN WHEEL CS-2151/-2152 JUMBO KING WR-335-901-X2 PFAFF KSM-200</p>
<p>SC34-LNS N</p>  <p>JUMBO KING WR-1125N SEIKO LZ2-990, -992 SERIES SEWSTAR CW-1105/-1125/ -1135 CW-1205/-1208/ -1225/-1235</p>	<p>SC34-LZNS N</p>  <p>JUKI LZH-1290/-4/-6</p>	<p>SC35-LNS N</p>  <p>BROTHER BE-0101B-AC/ -1201B-AC/-0901E -AC, BES-1210AC</p>
<p>SC35-XLNS N</p>  <p>BROTHER BAS-300G-484/SF BAS-326H-484/ -484SF KE-484C-X LK3-B484, KE-484C</p>	<p>SC367-NS N</p>  <p>DURKOPP/ADLER 367</p>	

Teflon 特氟隆内釜

DLC 像鑽石一樣堅硬的石炭塗層内釜

Ti 鈦塗層

ADJ 护针片調整旋梭

N 附防止空轉彈簧片

* = EXCLUSIVE ITEMS

BOBBIN CASE ZIGZAG TYPE: SC		
SC70-2  BROTHER DL1-B812/-B813 LH4-B814/-2/-3/-4 LZ1-B851 DURKOPP/ADLER 91/98/252/253/254 JUKI LBH-761, -762, -763 SUNSTAR DPK-2/-3	SC70-2M  SINGER 107G 107U202 107W1/3/5/17	SC70-2NS N  GOLDEN WHEEL CSH-7830 SINGER 107G 107U202 107W1/3/5/17
SC70-3  BROTHER LZ2-B852/-B853 JACK JK-457 mitsubishi LZ-720/-780/-790 ZOJE GG457 ZJ457A/457B/457D ZJ457A125/105/135	SC70-3JNS N  GEMSY 2284/2297 HIGHLEAD GC0068-1/-1D JUKI LZ2280/2290 SERIES MAQI PF22841114 ZOJE ZJ2290/2293	SC70-3WFLNS N  BROTHER HE-800A/-800B/ -800C Z-series, ZE-series SIRUBA BH790B LBHS-1790S SUNSTAR BH/3000/3100
SC70-771  GOLDEN WHEEL CSH-7800 K-CHANCE KBH-780 TAKING TK-888/-888VB	SC70-771NS N  JACK JK-781 JUKI LBH-771 MAQI LS7810301	SC70-LH3NS N  JACK JK-T1790BS-1 JUKI LBH-1792K LBH-791, -1790 MAQI LS-T1790B ZOJE ZJ5780BS, ZJ5781DS

Teflon HOOK BASE TEFLON

DLC HOOK BASE DLC COATING MINIMAL OIL

Ti HOOK BASE TITANIUM COATING

ADJ ADJUSTABLE STRONG NEEDLE GUARD

N WITH NON SLIP SPRING

* = EXCLUSIVE ITEMS

BOBBIN CASE SPECIAL TYPE: SC					
SC181	N	SC181H	N	SC335-V	N
 <p>MITSUBISHI PLK-G SERIES UNICORN UAS-H1407(M)</p>		 <p>CHNKI PT-2210/-3020 MAQI LS1310-E-35 MITSUBISHI PLK-G SERIES UNICORN UAS-H1407(H)</p>		 <p>GOLDEN WHEEL CS-335L PFAFF 335G</p>	

Teflon 特氟隆内釜



DLC 像鑽石一樣堅硬的石炭塗層内釜

Ti 鈦塗層

ADJ 护针片調整旋梭

N 附防止空轉彈簧片

* = EXCLUSIVE ITEMS

BOBBIN CASE SPECIAL TYPE: SC			
SC430	N	SC980-2 N	SC980N
 <p>BROTHER BE-438FX II KE-430 SERIES LK3-B4300 SERIES GOLDEN WHEEL CSK-8105-B430-2 HIGHLEAD HLK-03 MITSUBISHI PLK-03BTA</p>	 <p>GOLDEN WHEEL CS-8150 JUKI LK-1900 SERIES MAQI LS1900 SERIES SIRUBA LKS-1900 SERIES</p>	 <p>JUKI LK-282, -1850, -1900 SUNSTAR SPS/C(D)-B1202 SPS/C-B1201 UNICORN UAS-H900/-H903-DF ZOJE ZJ1900 SERIES</p>	

Teflon HOOK BASE TEFLON

DLC HOOK BASE DLC COATING MINIMAL OIL

Ti HOOK BASE TITANIUM COATING

ADJ ADJUSTABLE STRONG NEEDLE GUARD

N WITH NON SLIP SPRING

REFERENCE TO SEWING MACHINES

* = EXCLUSIVE ITEMS

ABLE (美宝)

MACHINE (机器)	HOOK (旋梭)					BOBBIN CASE & CAP (梭壳 & 梭帽)		
	PART NO. (配件型号)	KOBAN NO.1 (佐文型号1)	PAGE	KOBAN NO.2 (佐文型号2)	PAGE	PART NO. (配件型号)	KOBAN NO. (佐文型号)	PAGE
HB-100		KR21-R	8				SC31	24
HB-150/-500, HBS-5000		KR21-S	8				SC31	24
HB-300		KHS12-RP	1				SC31-NS N	24
HB-380		KHS20-GTB	4				SC33-L	26
HB-480		KHS12-S	2				SC31	24
HBS-2700		KHS12-SPD2	3				SC31-NS N	24
LT2-220BF		KRT12-5LM	13					
LT2-220ML		KRT12-5M	11					

BAIPU (百普)

MACHINE (机器)	HOOK (旋梭)					BOBBIN CASE & CAP (梭壳 & 梭帽)		
	PART NO. (配件型号)	KOBAN NO.1 (佐文型号1)	PAGE	KOBAN NO.2 (佐文型号2)	PAGE	PART NO. (配件型号)	KOBAN NO. (佐文型号)	PAGE
BP-1574H/-1591		SKRT592V2-R with Cap ADJ	16	KRT592V2-R hook only ADJ	16		SCPF572	23

BAOMA (宝马)

MACHINE (机器)	HOOK (旋梭)					BOBBIN CASE & CAP (梭壳 & 梭帽)		
	PART NO. (配件型号)	KOBAN NO.1 (佐文型号1)	PAGE	KOBAN NO.2 (佐文型号2)	PAGE	PART NO. (配件型号)	KOBAN NO. (佐文型号)	PAGE
GC0318-1		KHS12-SD	2				SC82-J	25
GC0378-1		KRT132	17					
GC128-M/158-M, HG128-M		KHS12-S	2				SC31	24
GC158-B, HG128-B		KHS12-R	1					
GC158-BD		KHS12-RP	1				SC31-NS N	24
GC158-MD		KHS12-SPD2	3					
GC2018/2318		KRT31-R	15					
GC20508-C		KRT12-5LM	13					
GC20508-M		KRT12-5M	11					
GC20538-C		SKRT12-5LMK with Cap	14	KRT12-5LMK hook only	14		SCP-LMK	23
GC20538-M		SKRT12-5MK with Cap	11	KRT12-5MK hook only	11		SCP-MK	23
GC20608-1, -2		KRT12-5LMC	13					
GC2318		KRT31-R	15					
GC2638-1		SKRT341-NR with Cap	20	KRT341-NR hook only	20		SCP545	23
GC2638-2		KRT31-11S	15					
HG128		KHS12-GTH	1				SC31	24

BAOYU (宝宇)

MACHINE (机器)	HOOK (旋梭)					BOBBIN CASE & CAP (梭壳 & 梭帽)		
	PART NO. (配件型号)	KOBAN NO.1 (佐文型号1)	PAGE	KOBAN NO.2 (佐文型号2)	PAGE	PART NO. (配件型号)	KOBAN NO. (佐文型号)	PAGE
781		KRP41-LH2	10				SC70-771	27
842-3		KRT842F-S	11					
842-5		KRT842H-S	11					
845-3/-5		SKRT845BK with Cap	12	KRT845BK hook only	12		SCP-842BK	23
8500		KHS12-S	2				SC31	24
8900		KHS12-SPD2	3				SC31-NS N	24

Teflon HOOK BASE TEFLON

DLC HOOK BASE DLC COATING
MINIMAL OIL

Ti HOOK BASE
TITANIUM COATING

ADJ ADJUSTABLE STRONG
NEEDLE GUARD

N WITH NON SLIP SPRING

* = EXCLUSIVE ITEMS

BARUDAN (百灵达)								
MACHINE (机器)	HOOK (旋梭)					BOBBIN CASE & CAP (梭壳 & 梭帽)		
	PART NO. (配件型号)	KOBAN NO.1 (佐文型号1)	PAGE	KOBAN NO.2 (佐文型号2)	PAGE	PART NO. (配件型号)	KOBAN NO. (佐文型号)	PAGE
BEDRH BEDSHE BEDSME BEDTHE BEDT-Z BEDXH BEDYHE BEMR BEMS ELITE	KF220711* KF220970* KF221062* KF221072*	KHS12-RYPBNW* Teflon KHS12-RYPBW* KHS12-RYPOEBW3* KHS12-RYPOEOBW3*		KHS12-RYPNW Teflon KHS12-RYPW KHS12-RYPOE KHS12-RYPOEO	2 2	KF221020	SC35-NS N	24
SC34-2NS N							24	

BEYOUNG (本佳)								
MACHINE (机器)	HOOK (旋梭)					BOBBIN CASE & CAP (梭壳 & 梭帽)		
	PART NO. (配件型号)	KOBAN NO.1 (佐文型号1)	PAGE	KOBAN NO.2 (佐文型号2)	PAGE	PART NO. (配件型号)	KOBAN NO. (佐文型号)	PAGE
BM-8B/-8B-2 BM-1340/-1340V		KRT31-R	15					
BM-1341/-1341V		SKRT341G with Cap	20	KRT341G hook only	20		SCP545	23
BM-1510/-1560		KRT11-5LJR	13					
BM-244/-244V		KHS12-GTPND2	1				SC82-JNS2 N	25
BM-246/-246V		KHS20-HPEW	4				SC33-LD N	26
BM-335BH/-652		KR24-B	8				SC34-1	24
BM-810/-820 BM-810H/-820H		KRT31-NR KRT31-SGH	15					
BM-842E-003/-005 BM-872E-005		KRT12-5M KRT12-5LM	11 13					
BM-9910/-9920		SKRT470-R with Cap	16	KRT470-R hook only	16		SCPF15	23
DB-J706 DB-J806/BM-0318-1		KHS12-R KHS20-RM2	1 4				SC31 SC33-L	24 26

BROTHER (兄弟)								
MACHINE (机器)	HOOK (旋梭)					BOBBIN CASE & CAP (梭壳 & 梭帽)		
	PART NO. (配件型号)	KOBAN NO.1 (佐文型号1)	PAGE	KOBAN NO.2 (佐文型号2)	PAGE	PART NO. (配件型号)	KOBAN NO. (佐文型号)	PAGE
BAS-23/-302	153131901	KHS12-SPD2	3			148350101	SC31-NS N	24
BAS-301	SA1704001	KHS12-SPB3OHO	2					
BAS-350/-360/-361	SA1722001	KHS20-SMP	5			151845001	SC33-LNS N	26
BAS-400	112041901	KR24-B	8			117596001	SC35	24
BAS-412/-416/-423	SA1646001	KHS20-RMP	4			151845001	SC33-LNS N	26
BAS-612/-613	SA1692102	SKRT875LK with Cap		KRT875LK hook only		S09279001	SCP-LBK	
BAS-6150/-6200	SA1694102	SKRT875LKC with Cap	14	KRT875LC hook only	14	S09280001	SCP-LBKC	23
BE-0101B-AC/-1201B-AC/ -0901E-AC, BES-1210AC	SA1646001	KHS20-RMP	4			S59992001	SC35-LNS N	26
BAS-300G-01/-03, -311F -01/-03, -311G-01/-03	SA8197101	SH311B	21					
BAS-300G-02/-311G -02/-311F-02/-L1/ -326F-02/-326G-02	SA2173301	SH311A	21					

Teflon 特氟隆内釜

DLC 像鑽石一樣堅硬的石炭塗層内釜

Ti 鈦塗層

ADJ 护针片调整旋梭

N 附防止空轉彈簧片

* = EXCLUSIVE ITEMS

BROTHER (兄弟)

MACHINE (机器)	HOOK (旋梭)					BOBBIN CASE & CAP (梭壳 & 梭帽)		
	PART NO. (配件型号)	KOBAN NO.1 (佐文型号1)	PAGE	KOBAN NO.2 (佐文型号2)	PAGE	PART NO. (配件型号)	KOBAN NO. (佐文型号)	PAGE
BAS-300G-484/SF	SA2036101	KHS30-RPNG	7			S00691401	SC35-XLNS N	26
BAS-310	S15662901	SH311A	21					
BAS-311HN/-05, -326H-05	SA8197101	SH311B	21					
BAS-311HN-03, -311F-02/-L1, -311G-02	SA2173301	SH311A	21					
BAS-311HN-07A, -326H-07A, -311F -01/03, -311G-0/03	SA8197101	SH311B	21					
BAS-326F-01/-03, -326G-01/-03, -326H	SA8197101	SH311B	21					
BAS-326F-02/ -326G-02/-326H/-03	SA2173301	SH311A	21					
BAS-326H-484/ -484SF	SA2036101	KHS30-RPNG	7			S00691401	SC35-XLNS N	26
BAS-341F-01/ -342F-01, -341H/-05	SA8197101	SH311B	21					
BAS-341F-02/-342F -02/-341H/-342H	SA2173301	SH311A	21					
BAS-342G, -342H/ -05, -360H, -365H	SA8197101	SH311B	21					
BAS-7050	SA2173301	SH311A	21					
BAS-7050	SA8197101	SH311B	21					
BE-430FS II -03/-0K/-01, -430FX II -03/-0K/-01	SA1881001/152685301	SH430	21			159610401	SC430 N	29
BE-430FX II -05/ -430FS II -05	SA1882001/152687201	SH430-H	21			152690501		
BE-430FX II -05/ -430FS II -05	SA8197101	SH311B	21					
BE-438FX II / -438FX II -01/-03/-0K	SA1881001/152685301	SH430	21			159610401	SC430 N	29
BE-438FX II -05	SA1882001/152687201	SH430-H	21			159610401		
BE-438FX II -05	SA8197101	SH311B	21					
BE-438HX/-438HS	SA1881001/152685301	SH430	21			159610401	SC430 N	29
DB1-B760-3	111274901	KR21-T						
DB1-B760-5	111272901	KR21-R	8					
DB2-B714-1/-B736-1/ -3, -B757-3/-5, -B758, -B773/-3/-A	SA1706001	KHS12-SB2	2	KHS12-S	2	100369001	SC31	24
DB2-B736-5	SA1708001	KHS12-SB3OHO	2			148350101	SC31-NS N	24
DB2-B737-3/-B738-3/ -B778/-B7740/-B7741	SA1931002	KHS12-SPB	2					
DB2-B737-5, -B738-5, -B790-5-0/-505, -B791-5-0	SA1704001	KHS12-SPB3OHO	2					
DB2-B741-3, -B747-5/-7	SA1722001	KHS20-SMP	5			151845001	SC33-LNS N	26
DB2-B745-5/-B746 -8/-B746A	SA1723001	KHS20-GTB	4					
DB2-B745-5/-7, -B746 -7, -B771, -B797-5	SA1720001	KHS20-RTB	5					
DB2-B748-307	SA1646001	KHS20-RMP	4					
DB2-B748A, -B749 -307, -B798/-300	SA1722001	KHS20-SMP	5					

Teflon HOOK BASE TEFLON

DLC HOOK BASE DLC COATING
MINIMAL OIL

Ti HOOK BASE
TITANIUM COATING

ADJ ADJUSTABLE STRONG
NEEDLE GUARD

N WITH NON SLIP SPRING

* = EXCLUSIVE ITEMS

BROTHER (兄弟)								
MACHINE (机器)	HOOK (旋梭)					BOBBIN CASE & CAP (梭壳 & 梭帽)		
	PART NO. (配件型号)	KOBAN NO.1 (佐文型号1)	PAGE	KOBAN NO.2 (佐文型号2)	PAGE	PART NO. (配件型号)	KOBAN NO. (佐文型号)	PAGE
DB2-B755-3	SA1706001	KHS12-SB2	2	KHS12-S	2	100369001	SC31	24
DB2-B755-5	111275901	KHS12-R	1					
DB2-B757/-103/-105/ -203/-205/-3/-403/ -405/-503/-505	153131901	KHS12-SPD2	3			148350101	SC31-NS N	24
DB2-B767/-5	111272901	KR21-R	8					
DB2-B771/ -B790/-B791-3	SA1715001	KHS12-SD	2			100369001	SC31	24
DB2-B774/-B7740/ -B7741/-B778/-DD7100	SA1931002	KHS12-SPB	2			148350101	SC31-NS N	24
DB2-B781/-1/-2-3, -B792-003/-013/-015/ -017, -B795-013	SA1706001	KHS12-SB2	2	KHS12-S	2	100369001	SC31	24
DB2-B784-103/-104/-203/ -204/-3-0/-4/-803/-804	153131901	KHS12-SPD2	3			148350101	SC31-NS N	24
DB2-B790-3/ -303, -B791-333	147101902	KHS12-SPD3	2					
DB2-B790-5/-B791-5	140882901	KHS12-RD	1			100369001	SC31	24
DB2-B792-3-0/ -400/-503/-613	153131901	KHS12-SPD2	3			148350101	SC31-NS N	24
DB2-B793/-303/-305, -B795/-313	153131901	KHS12-SPD2	3					
DL1-B812/-B813	180038901	KRP41-R	10			107097101	SC70-2	27
HE-8000-2/-3/-5	SA1744001	KRP800B		KRP800BTI Ti	10	S50237001		
HE-800A/-800B/ -800C	SB0548001	KRP800BTI Ti	10			SA9138001	SC70-3WFLNS N	27
HM-8180	SA1746001	KRP818	10			S50237001		
KE-430C, -430F-03/0K, -431F-OF, -430FX II -03/ -OK/-01	SA1881001/152685301	SH430	21					
KE-430HS-03/0K/-01, -430HX-03/-OK/-01, -434C-1	SA1881001/152685301	SH430	21			159610401	SC430 N	29
KE-430C/-430F-05/ -430FX II -05/ -430HS-05/430HX-05	SA1882001/152687201	SH430-H	21					
KE-434C-2/-435-C	SA1882001/152687201	SH430-H	21			152690401	SC430 N	29
KE-430F-05/-430FX II -05/ -430HS-05/-430HX-05	SA8197101	SH311B	21					
KE-434C-1	SA2173301	SH311A	21					
KE-434C-2/-435-C	SA1890001	SH311B	21					
KE-484C-X	SA2036101/S00688901	KHS30-RPNG	7			S00691401	SC35-XLNS N	26
LE2-B861-1	117677001	KR24	8			117596001	SC35	24
LE2-B861-7	112041901	KR24-B	8					
LH4-B800E-2	SA1744001	KRP800B		KRP800BTI Ti	10	S50237001	SC70-3WFLNS N	27
LH4-B814/-2/-3/-4	141307901	KRP41-B	10			107097101	SC70-2	27
LK3-B220/-B221/ -B222/-B223/-B826/ -B827/-B828	116827901	SH61-NG	22					

Teflon 特氟隆内釜

DLC 像鑽石一樣堅硬的石炭塗層内釜

Ti 鈦塗層

ADJ 护针片調整旋梭

N 附防止空轉彈簧片

* = EXCLUSIVE ITEMS

BROTHER (兄弟)

MACHINE (机器)	HOOK (旋梭)					BOBBIN CASE & CAP (梭壳 & 梭帽)		
	PART NO. (配件型号)	KOBAN NO.1 (佐文型号1)	PAGE	KOBAN NO.2 (佐文型号2)	PAGE	PART NO. (配件型号)	KOBAN NO. (佐文型号)	PAGE
LK3-B4300E/-B430E/ -B4310E/-B431E/ -B4320E/ -B432E/-B4330E/-B433E/ -B4340E/-B434E/-B435/ -B4350E/-B436/-B4380E/ -B438E/-B441	SA1881001/152685301	SH430	21			159610401	SC430 N	29
LK3-B430E/-B431E/ -B432E/-B433E/-B434E/ -B435/-B436/-B441	SA1882001/152687201	SH430-H	21					
LK3-B484, KE-484C	SA2036101	KHS30-RPNG	7			S00691401	SC35-XLNS N	26
LS2-B891	SA1429001	KRT467						
LT2-B831/-3, -B832-1/3,-B833	112691901	KRT12-5BF	11					
LT2-B831-5/-B832-5	144903901	KRT12-5BH						
LT2-B832-3-0/ -401/-403	158760901	KRT12-5BFCI						
LT2-B835/-3/-5/-800	150371901	SKRT12-5BFKC-S2 with Cap		KRT12-5BFKC-S2 hook only		151041001	SCP-842BK	23
LT2-B835-3-0/ -5-0/-400/-500	158760901	KRT12-5BFCI						
LT2-B835-5-0	158761001	SKRT12-5BFKC with Cap		KRT12-5BFKC hook only		151044001	SCP-842BKC	23
LT2-B836/-3	155466901	SKRT12-5LBK2 with Cap		KRT12-5LBK2 hook only		155476001	SCP-LMKC2	
LT2-B837/-5	150966901	KRT-LS2R	13					
LT2-B837-300	156379911	KRT-LS2CI-S	13					
LT2-B838/-5	153912901	KRT-LS2S						
LT2-B841	SA1670111	SKRT842FK-S with Cap	12	KRT842FK-S hook only	12	S07740001	SCP-842BC	23
LT2-B841-3/-B842-3	SA1668111	KRT842F-S	11					
LT2-B841-5/-B842-5	SA1669111	KRT842H-S	11					
LT2-B842/-B842-403/ -405/-903/-905	SA1678111	SKRT842C with Cap	11	KRT842KC hook only	11	S07740001	SCP-842BC	23
LT2-B842/-B842-403/ -405/-903/-905	SA1677111	KRT842CI	11					
LT2-B845/-3/-5/-7	SA1681111	SKRT845BK with Cap	12	KRT845BK hook only	12	S07741001	SCP-842BK	23
LT2-B845-403/-405/ -407/-903/-905/-907	SA1683111	SKRT845KC with Cap	12	KRT842KC hook only	12	S07742001	SCP-842BKC	23
LT2-B847-1	SA1670111	SKRT842FK-S with Cap	12	KRT842FK-S hook only		S07740001	SCP-842BC	23
LT2-B847-1	SA1668111	KRT842F-S	11					
LT2-B847-401/-901	SA1677111	KRT842CI	11					
LT2-B847-401/-901	SA1678111	SKRT842C with Cap	11	KRT842KC hook only	11	S07740001	SCP-842BC	23
LT2-B848-1	SA1681111	SKRT845BK with Cap	12	KRT845BK hook only	12	S07741001	SCP-842BK	23
LT2-B848-401	SA1683111	SKRT845KC with Cap	12	KRT842KC hook only	12	S07742001	SCP-842BKC	23
LT2-B872-3/5	SA1685102	KRT872L	13					
LT2-B872-403/ 405/903/905	SA1689102	SKRT872LC with Cap	14	KRT875LC hook only	14	S09278001	SCP-LBC	23

Teflon HOOK BASE TEFLON

DLC HOOK BASE DLC COATING
MINIMAL OIL

Ti HOOK BASE
TITANIUM COATING

ADJ ADJUSTABLE STRONG
NEEDLE GUARD

N WITH NON SLIP SPRING

BROTHER (兄弟)								
MACHINE (機器)	HOOK (旋梭)					BOBBIN CASE & CAP (梭壳 & 梭帽)		
	PART NO. (配件型号)	KOBAN NO.1 (佐文型号1)	PAGE	KOBAN NO.2 (佐文型号2)	PAGE	PART NO. (配件型号)	KOBAN NO. (佐文型号)	PAGE
LT2-B875/-3/-5/-7	SA1692102	SKRT875LK with Cap		KRT875LK hook only		S09279001	SCP-LBK	
LT2-B875/-403/-405/ -407/-903/-905	SA1694102	SKRT875LKC with Cap	14	KRT875LC hook only	14	S09280001	SCP-LBKC	23
LT2-B875/-403/-405/ -407/-903/-905	SA1692102	SKRT875LKCH with Cap		KRT875LCH hook only		S09280001	SCP-LBKCH	
LT2-B882	156514901	KRT12-5LB						
LT2-B892	SA1429001	KRT467						
LZ1-B851	180038901	KRP41-R	10			107097101	SC70-2	27
S-1110A-3	SA1706001	KHS12-SB2	2	KHS12-S	2	100369001	SC31	24
S-1110A-5	SA1708001	KHS12-SB3OHO	2					
S-6200DD-303/-403	SA7686102	KHS12-SPD2	3			S03245001		
S-7200A-403/-433	SA1931002	KHS12-SPB	2					
S-7200A-405/-1010-5/-2010 -5/-737A-5, S-7200B-305	SA1704001	KHS12-SPB3OHO	2			148350101	SC31-NS N	24
S-7200B/-303, -7200C -303/-333, -7220B-403/ -405, -7220C-3	SA7686102	KHS12-SPD2	3			S03245001	SC31-NS N	24
SL-1010-3/-1110-2/ -777A-3	SA1706001	KHS12-SB2	2	KHS12-S	2	100369001	SC31	24
SL-2010-3/-778A-3	SA1931002	KHS12-SPB	2			148350101	SC31-NS N	24
SL-2010-5/-737A-5	SA1704001	KHS12-SPB3OHO	2					
SL-746A	SA1720001	KHS20-RTB	5			151845001	SC33-LNS N	26
SN-7230-5/-7240-5	SA1722001	KHS20-SMP	5					
SN-771A-3	SA1715001	KHS12-SD	2			100369001	SC31	24
T-8420A-005/ -8420B-005	SA1669111	KRT842H-S	11					
T-8420A-00F/-033/-03F, -8421A-T03/-T33/-T3F	SA1668111	KRT842F-S	11					
T-8420C-003/-033/ -03F	SA1670111	SKRT842FK-S with Cap	12	KRT842FK-S hook only	12	S07740001	SCP-842BC	23
T-8421A-T03	SA1670111	SKRT842FK-S with Cap	12	KRT842FK-S hook only	12			
T-8421A-T05	SA1669111	KRT842H-S	11					
T-8421A-T03/-T33/-T3F	SA1668111	KRT842F-S	11					
T-8421C-T03/-T3F/ -TOF/-T33	SA1668111	KRT842F-S	11					
T-8421C-T03/-T3F	SA1670111	SKRT842FK-S with Cap	12	KRT842FK-S hook only	12	S07740001	SCP-842BC	23
T-8421C-T0F/-T33	SA1670111	SKRT842FK-S with Cap	12	KRT842FK-S hook only	12			
T-8422A-403/ -405/-433	SA1677111	KRT842CI	11					
T-8422A-403	SA1678111	SKRT842C with Cap	11	KRT842KC hook only	11	S07740001	SCP-842BC	23
T-8422C-403/-433	SA1678111	SKRT842C with Cap	11	KRT842KC hook only	11			
T-8450A-003/ -005/-033	SA1681111	SKRT845BK with Cap	12	KRT845BK hook only	12	S07741001	SCP-842BK	23
T-8450C-003	SA1681111	KRT842F-S	11					
T-8452A-403/-405/-406, -8452C-403	SA1683111	SKRT845KC with Cap	12	KRT842KC hook only	12	S07742001	SCP-842BKC	23

Teflon 特氟隆内釜

DLC 像鑽石一樣堅硬的石炭塗層内釜

Ti 鈦塗層

ADJ 护针片調整旋梭

N 附防止空軋彈簧片

* = EXCLUSIVE ITEMS

BROTHER (兄弟)

MACHINE (机器)	HOOK (旋梭)					BOBBIN CASE & CAP (梭壳 & 梭帽)		
	PART NO. (配件型号)	KOBAN NO.1 (佐文型号1)	PAGE	KOBAN NO.2 (佐文型号2)	PAGE	PART NO. (配件型号)	KOBAN NO. (佐文型号)	PAGE
T-8720A-003/-005	SA1685102	KRT872L	13					
T-8722A-403/-405	SA1689102	SKRT872LC with Cap	14	KRT875LC hook only	14	S09278001	SCP-LBC	23
T-8750A-003/-005	SA1692102	SKRT875LK with Cap		KRT875LK hook only		S09279001	SCP-LBK	
T-8752A-403/-405	SA1694102	SKRT875LKC with Cap	14	KRT875LC hook only	14	S09280001	SCP-LBKC	23
TA1-B621, TA2-B622	111274901	KR21-T				100369001	SC31	24
TL-847A	SA1668111	KRT842F-S	11					
TL-847B	SA1677111	KRT842CI	11					
TL-848A	SA1681111	SKRT845BK with Cap	12	KRT845BK hook only	12	S07741001	SCP-842BK	23
TL-848B	SA1683111	SKRT845KC with Cap	12	KRT842KC hook only	12	S07742001	SCP-842BKC	23
TN-842A-003/-00F	SA1668111	KRT842F-S	11					
TN-842A-005	SA1669111	KRT842H-S	11					
TN-842B-403/-405	SA1677111	KRT842CI	11					
TN-842B-40F	SA1678111	SKRT842C with Cap	11	KRT842KC hook only	11	S07740001	SCP-842BC	23
TN-845A-003/-005	SA1681111	SKRT845BK with Cap	12	KRT845BK hook only	12	S07741001	SCP-842BK	23
TN-845A-403/-405, -845B-401/-403/-405	SA1683111	SKRT845KC with Cap	12	KRT842KC hook only	12	S07742001	SCP-842BKC	23
TN-872A-003/-005	SA1685102	KRT872L	13					
TN-872B-403/-405	SA1689102	SKRT872LC with Cap	14	KRT875LC hook only	14	S09278001	SCP-LBC	23
TN-875A-003/-005	SA1692102	SKRT875LK with Cap		KRT875LK hook only		S09279001	SCP-LBK	
TZ1-B651/-B652	112041901	KR24-B	8			117596001	SC35	24
LZ2-B852/ -B853/-B854	S34847901	KRP457	10			158471001	SC70-3	27
Z-series, ZE-series	SA8194001/ SA1853001	KRP856Ti Ti	10	KRP856ICC DLC		SA8127001/ S48202101	SC70-3WFLNS N	27

BUTTERFLY (蝴蝶)

MACHINE (机器)	HOOK (旋梭)					BOBBIN CASE & CAP (梭壳 & 梭帽)		
	PART NO. (配件型号)	KOBAN NO.1 (佐文型号1)	PAGE	KOBAN NO.2 (佐文型号2)	PAGE	PART NO. (配件型号)	KOBAN NO.1 (佐文型号)	PAGE
GC2-1/57-1, GG2-1		KR24	8				SC35	24
GC25-1/-2, GC2601		KHS12-S	2				SC31	24
GG305-1		KHS12-RYP	1				SC35-NS N	24
GG3-1		KRP457	10				SC70-3	27
GY4-1		KRP41-LH2	10				SC70-771	27

CHIKON (奇鋼)

MACHINE (机器)	HOOK (旋梭)					BOBBIN CASE & CAP (梭壳 & 梭帽)		
	PART NO. (配件型号)	KOBAN NO.1 (佐文型号1)	PAGE	KOBAN NO.2 (佐文型号2)	PAGE	PART NO. (配件型号)	KOBAN NO. (佐文型号)	PAGE
CK-1461		KSP204	18					
CK-1508/-1508-25		KRT11-5LJR	13					
CK-1560/-1560-25		KRT11-5LJR	13					

Teflon HOOK BASE TEFLON

DLC HOOK BASE DLC COATING
MINIMAL OIL

Ti HOOK BASE
TITANIUM COATING

ADJ ADJUSTABLE STRONG
NEEDLE GUARD

N WITH NON SLIP SPRING

* = EXCLUSIVE ITEMS

CHIKON (奇鋼)

MACHINE (機器)	HOOK (旋梭)					BOBBIN CASE & CAP (梭壳 & 梭帽)		
	PART NO. (配件型号)	KOBAN NO.1 (佐文型号1)	PAGE	KOBAN NO.2 (佐文型号2)	PAGE	PART NO. (配件型号)	KOBAN NO. (佐文型号)	PAGE
CK-1541/-1541-25		KHS20-HPEW	4				SC33-LD N	26
CK-243/-273/-441/ -461/-471/-1461		KSP204N	18					
CK-563/-1508/ -1508-25,-1560/1560-25		KRT12-5LJH-R						
CK-8BL/-8BL-1, STH-8BL		KHS20-RPEM2AO	5				SC33-LD N	26

CHNKI (中縫)

MACHINE (機器)	HOOK (旋梭)					BOBBIN CASE & CAP (梭壳 & 梭帽)		
	PART NO. (配件型号)	KOBAN NO.1 (佐文型号1)	PAGE	KOBAN NO.2 (佐文型号2)	PAGE	PART NO. (配件型号)	KOBAN NO. (佐文型号)	PAGE
CBH-781U/-1780		KRP41-LH2	10				SC70-771	27
CBH-1790		KRP41-LH3ICC DLC	10				SC70-LH3NS N	27
CLK-1850U/-1900D/ -1902D/-1903D/ -1905D/-1905DF- II		SH280	21				SC980N	29
GC812/913		KHS20-SMP	5				SC33-LNS N	26
PT-2210/-3020		SH181H	21				SC181H N	28

CHUAN NENG (傳能)

MACHINE (機器)	HOOK (旋梭)					BOBBIN CASE & CAP (梭壳 & 梭帽)		
	PART NO. (配件型号)	KOBAN NO.1 (佐文型号1)	PAGE	KOBAN NO.2 (佐文型号2)	PAGE	PART NO. (配件型号)	KOBAN NO. (佐文型号)	PAGE
CN-990-3		KHS12-S	2				SC31	24
CN-990-5/-7		KHS12-R	1					
CN-991-3/-5/-7, CN992-5/-7		KHS12-RP	1				SC31-NS N	24
CN-991-3/-992-3		KHS12-SPD2	3					

CHUAN WANG (莊旺)

MACHINE (機器)	HOOK (旋梭)					BOBBIN CASE & CAP (梭壳 & 梭帽)		
	PART NO. (配件型号)	KOBAN NO.1 (佐文型号1)	PAGE	KOBAN NO.2 (佐文型号2)	PAGE	PART NO. (配件型号)	KOBAN NO. (佐文型号)	PAGE
CW-1105-N/-1205-N		KHS20-TZ	6				SC34-LNS N	26
CW-457A-143N-L		KRP457-W	10				SC70-3	27

CHURCHILL (求精)

MACHINE (機器)	HOOK (旋梭)					BOBBIN CASE & CAP (梭壳 & 梭帽)		
	PART NO. (配件型号)	KOBAN NO.1 (佐文型号1)	PAGE	KOBAN NO.2 (佐文型号2)	PAGE	PART NO. (配件型号)	KOBAN NO. (佐文型号)	PAGE
QJ2230B		KRT12-5LM	13					
QJ2230M		KRT12-5M	11					
QJ2250		SKRT12-5MK with Cap	11	KRT12-5MK hook only	11		SCP-MK	23
QJ2250B		SKRT12-5LMK with Cap	14	KRT12-5LMK hook only	14		SCP-LMK	23
QJ5200/5550/8700/8900		KHS12-S	2				SC31	24
QJ842-3		KRT842F-S	11					
QJ842-5		KRT842H-S	11					
QJ845		SKRT845BK with Cap	12	KRT845BK hook only	12		SCP-842BK	23
QJ872		KRT872L	13					
QJ875		SKRT875LK with Cap		KRT875LK hook only			SCP-LBK	

Teflon 特氟隆内釜

DLC 像鑽石一樣堅硬的石炭塗層内釜

Ti 鈦塗層

ADJ 护针片調整旋梭

N 附防止空轉彈簧片

* = EXCLUSIVE ITEMS

CONSEW (康秀)

MACHINE (机器)	HOOK (旋梭)					BOBBIN CASE & CAP (梭壳 & 梭帽)		
	PART NO. (配件型号)	KOBAN NO.1 (佐文型号1)	PAGE	KOBAN NO.2 (佐文型号2)	PAGE	PART NO. (配件型号)	KOBAN NO. (佐文型号)	PAGE
120	2120304-310B	KHS20-S	5			2120304-301	SC33-L	26
133A	279	KR24-T				284	SC35-T	24
139/224/225/226/237/239	10655	KRT11-5	11					
146RB	712	KHS20-TZ	6			714	SC34-L	26
175/175RB	2130104-300B	KHS20-ST	5			2130104-301C	SC34-L	26
205RB	18849	KHS20-RM3	4			1144	SC33-LNS N	26
205RBH	10017	KHS20-RPE					SC33	24
206RB/306RB	18033	KHS20-RPEM2AO	5			18045	SC33-LD N	26
207/223/227	13086	KRT31-11S	15					
228/229/229R/229R-1/ 238/282/289	12032	KRT31-R	15					
230/231R/291R/318R	2113004-310	KHS12-S	2			2110104-301C	SC31	24
230B/231RH/291RH	2110904-310	KHS12-GTH	1			2110104-301C	SC31	24
244/254B/255	15040	KRT-LSR	13					
277R	17033	KR69-V	9			17034	SC39-14	24
290RATCW/291RATCW	2111704-310C	KHS12-SPA3				2111604-301C	SC31-NS N	24
312RATC/314RATC/ 315RATC	2111704-310C	KHS12-SPA3				2111604-301C	SC31-NS N	24
315R	2121604-310B	KHS12-SD	2			2110104-301C	SC31	24
327R-1	16291	SKRT12-5BK hook only	11	KRT12-5BK with Cap	11		SCP-BK	23
327RB-1	15850	SKRT26-L hook only		KRT26-L with Cap			SCP26-L	
328RB-1	16407	SKRT-BL hook only		KRT-BL with Cap			SCP-BL	
332	15875	KRT12-5B	11					
333/339	15502	KRT-LSS	14					
347	B49	KRP457	10				SC70-3	27
357/358/359	12032	KRT31-R	15					
382/388/389	13086	KRT31-11S	15					
722/825	279	KR23-16	8			284	SC35-T	24
744R/745R	70140C	KRT14-5-O	17					
757	28837C	KSP204	18					
SK-6/-7/-8	1343C	KRT132	17					

CUEY FENG (貴峰)

MACHINE (机器)	HOOK (旋梭)					BOBBIN CASE & CAP (梭壳 & 梭帽)		
	PART NO. (配件型号)	KOBAN NO.1 (佐文型号1)	PAGE	KOBAN NO.2 (佐文型号2)	PAGE	PART NO. (配件型号)	KOBAN NO. (佐文型号)	PAGE
GF204/CM		KSP204	18					
GF204-221/221-205		KRT14-5HP	17					
GF204-370/205/ 205-335/205-370		KSP204N	18					

Teflon HOOK BASE TEFLON

DLC HOOK BASE DLC COATING
MINIMAL OIL

Ti HOOK BASE
TITANIUM COATING

ADJ ADJUSTABLE STRONG
NEEDLE GUARD

N WITH NON SLIP SPRING

* = EXCLUSIVE ITEMS

DADILI (大地利)

MACHINE (機器)	HOOK (旋梭)					BOBBIN CASE & CAP (梭壳 & 梭帽)		
	PART NO. (配件型号)	KOBAN NO.1 (佐文型号1)	PAGE	KOBAN NO.2 (佐文型号2)	PAGE	PART NO. (配件型号)	KOBAN NO. (佐文型号)	PAGE
DB2-B111-3		KHS12-S	2				SC31	24
DB2-B111-5		KHS12-R	1					
DL-311G-02S		SH181H	21				SC181H N	28
DL430D-01		SH430	21					
DL430D-02		SH430-H	21				SC430 N	29
LT2-B842-3		KRT842F-S	11					
LT2-B842-5		KRT842H-S	11					
LT2-B845-3/-5		SKRT845BK with Cap	12	KRT845BK hook only	12		SCP-842BK	23
LT2-B872-3/-5		KRT872L	13					
LT2-B875-3/-5		SKRT875LK with Cap		KRT875LK hook only			SCP-LBK	

DALIAN (大連)

MACHINE (機器)	HOOK (旋梭)					BOBBIN CASE & CAP (梭壳 & 梭帽)		
	PART NO. (配件型号)	KOBAN NO.1 (佐文型号1)	PAGE	KOBAN NO.2 (佐文型号2)	PAGE	PART NO. (配件型号)	KOBAN NO. (佐文型号)	PAGE
G18		KRP41-LH2	10				SC70-771	27
GD2308		SH280	21				SC980N	29

DOSO (大森)

MACHINE (機器)	HOOK (旋梭)					BOBBIN CASE & CAP (梭壳 & 梭帽)		
	PART NO. (配件型号)	KOBAN NO.1 (佐文型号1)	PAGE	KOBAN NO.2 (佐文型号2)	PAGE	PART NO. (配件型号)	KOBAN NO. (佐文型号)	PAGE
DS-9895-HL		KHS20-SMP	5				SC33-LNS N	26
S10-D-HL		KHS20-RMP	4				SC33-LNS N	26

DURKOPP/ADLER (杜克普/愛華)

MACHINE (機器)	HOOK (旋梭)					BOBBIN CASE & CAP (梭壳 & 梭帽)		
	PART NO. (配件型号)	KOBAN NO.1 (佐文型号1)	PAGE	KOBAN NO.2 (佐文型号2)	PAGE	PART NO. (配件型号)	KOBAN NO. (佐文型号)	PAGE
67/68	068-00-181-4 W/O CAP	KRT67	15			068-00-178-4	SCP67	
69-373	69-00-581-4 W/O BC	KR69	9				SC39	24
91/98/252/253/254/255/264	098-15-007-4 W/O BC	KRP41-S	10			098-00-178-4	SC70-2	27
96	096-15-281-4 W/O BC	KR21-S	8			097-00-178-4	SC31	24
167/168/267/268	167-00-181-4 W/O CAP	KRT167				167-178-4	SCP167	
199/289/489	199-15-281-4 W/O BC	K23-16	8			189-00-178-4	SC35-T	24
204/205	204-15-010-4	KSP204	18					
206/207/270	204695	KR21-S	8			204335	SC31	24
220	220-181-4	KRT14-5	17					
265	265-21-142	KRT132	17					
271	271751	KHS271-S	7			271150144	SC33-NS N	24
296/396	396-15-181-4 W/O BC	KHS29K				89-178-C	SC83	
367	0367 155014	KHS367-SP	7			0367 1550044	SC367-NS N	26
460	460243	KRP108-R						
467	467-15-009-4	KRT467 ADJ						
467XXL/767XXL	0767150334	KRT467XLI-R ADJ	19					
570	570-1242	SH570	21					
768	0768 151834	KRT768I-ICC-R DLC	19					
867XXL/1767 XXL	0667 155634	KRT867XLI-R ADJ	19	KRT867XLI-ICC-R DLC ADJ				
467XXL/767 XXL	0767 150334	KRT467XLI-R ADJ	19					

Teflon 特氟隆内釜

DLC 像鑽石一樣堅硬的石炭塗層内釜

Ti 鈦塗層

ADJ 护针片調整旋梭

N 附防止空轉彈簧片

* = EXCLUSIVE ITEMS

FANG HUNG (方宏/PLATINA)

MACHINE (机器)	HOOK (旋梭)					BOBBIN CASE & CAP (梭壳 & 梭帽)		
	PART NO. (配件型号)	KOBAN NO.1 (佐文型号1)	PAGE	KOBAN NO.2 (佐文型号2)	PAGE	PART NO. (配件型号)	KOBAN NO. (佐文型号)	PAGE
TJ-3300		KHS20-R	4				SC33-L	26
TJ-335/-335H-BH/-652		KR24-B	8				SC35	24
TJ-457		KRP457-W	10				SC70-3	27
TJ-457A		KRP457	10				SC70-3	27
TJ-842		KRT12-5BF	11					
TJ-845		SKRT12-5BK with Cap	11	KRT12-5BK hook only	11		SCP-BK	23
TJ-8700		KHS12-S	2				SC31	24
TJ-8700-7		KHS12-SPD2	3				SC31-NS N	24

FEIYUE (飛躍)

MACHINE (机器)	HOOK (旋梭)					BOBBIN CASE & CAP (梭壳 & 梭帽)		
	PART NO. (配件型号)	KOBAN NO.1 (佐文型号1)	PAGE	KOBAN NO.2 (佐文型号2)	PAGE	PART NO. (配件型号)	KOBAN NO. (佐文型号)	PAGE
GC1-5/-6		KR21-S	8				SC31	24
GC15-1/-2/-4, GC290/5530/5550		KHS12-S	2					
GC15-3,28-1/-3		KHS12-GTH	1					
GC29-1,GG30		KR24	8				SC35	24

FENG YING (鋒穎)

MACHINE (机器)	HOOK (旋梭)					BOBBIN CASE & CAP (梭壳 & 梭帽)		
	PART NO. (配件型号)	KOBAN NO.1 (佐文型号1)	PAGE	KOBAN NO.2 (佐文型号2)	PAGE	PART NO. (配件型号)	KOBAN NO. (佐文型号)	PAGE
FY-241/246/246V		KHS20-HPEW	4				SC33-LD N	26
FY-245/-245V		KHS12-GTPND2	1				SC82-J	25
FY-341		SKRT341G with Cap	20	KRT341G hook only	20		SCP545	23
FY-810/-820/-985		KRT31-NR	15					

FLYINGMAN (飛人)

MACHINE (机器)	HOOK (旋梭)					BOBBIN CASE & CAP (梭壳 & 梭帽)		
	PART NO. (配件型号)	KOBAN NO.1 (佐文型号1)	PAGE	KOBAN NO.2 (佐文型号2)	PAGE	PART NO. (配件型号)	KOBAN NO. (佐文型号)	PAGE
GC20502-4		KRT12-5M	11					
GC20601		KHS20-R	4				SC33-L	26
GC51-1/9002		KHS12-S	2				SC31	24
GC9002H		KHS12-R	1					
GG0802		KR24	8				SC35	24
GG302		KRP457	10				SC70-3	27

FOMAX

MACHINE (机器)	HOOK (旋梭)					BOBBIN CASE & CAP (梭壳 & 梭帽)		
	PART NO. (配件型号)	KOBAN NO.1 (佐文型号1)	PAGE	KOBAN NO.2 (佐文型号2)	PAGE	PART NO. (配件型号)	KOBAN NO. (佐文型号)	PAGE
KDD-5570		KHS12-S	2				SC31	24
KDD-5570-7		KHS12-SPD2	3				SC31-NS N	24
KDD-5570H		KHS12-GTH	1				SC31	24
KDD-5570H-7		KHS12-GTHPD	1				SC31-NS N	24
KDD-5570HB		KHS20-R	4				SC33-L	26

Teflon HOOK BASE TEFLON

DLC HOOK BASE DLC COATING
MINIMAL OIL

Ti HOOK BASE
TITANIUM COATING

ADJ ADJUSTABLE STRONG
NEEDLE GUARD

N WITH NON SLIP SPRING

* = EXCLUSIVE ITEMS

GEMSY (宝石)								
MACHINE (机器)	HOOK (旋梭)					BOBBIN CASE & CAP (梭壳 & 梭帽)		
	PART NO. (配件型号)	KOBAN NO.1 (佐文型号1)	PAGE	KOBAN NO.2 (佐文型号2)	PAGE	PART NO. (配件型号)	KOBAN NO. (佐文型号)	PAGE
8900H-7, 8957EB		KHS12-RP	1				SC31-NS N	24
8900-7/8957		KHS12-SPD2	3					
8957E3		KHS20-SMP	5				SC33-LNS N	26
875-7		SKRT875LKC with Cap	14	KRT875LC hook only	14		SCP-LBKC	23
872-7		SKRT872LC with Cap	14	KRT875LC hook only	14		SCP-LBC	23
7-18A		KHS20-R	4				SC33-L	26
5590H/7-28H/8700H/ 8801E/8900H		KHS12-R	1					
736/5550/7070/7080/7-18/ 7-28/736/8500/8700/ 8801E/8900/GEM5550		KHS12-S	2				SC31	24
2284/2297		KRP457JTI Ti	10	KRP457JICC DLC	10		SC70-3JNS N	27
20U23/123T, 20U33/43, 20U42		KR24U-42	9				SC35-NS N	24
2001-1B		KRT12-5LM	13					
2000-2M		SKRT12-5MK with Cap	11	KRT12-5MK hook only	11		SCP-MK	23
2000-2B		SKRT12-5LMK with Cap	14	KRT12-5LMK hook only	14		SCP-LMK	23
2000-1M		KRT12-5M	11					
1790		KRP41-LH3ICC DLC	10				SC70-LH3NS N	27
875		SKRT875LK with Cap		KRT875LK hook only			SCP-LBK	
872		KRT872L	13					
845		SKRT845BK with Cap	12	KRT845BK hook only	12		SCP-842BK	23
842		KRT842CI	11					

GLOBAL								
MACHINE (机器)	HOOK (旋梭)					BOBBIN CASE & CAP (梭壳 & 梭帽)		
	PART NO. (配件型号)	KOBAN NO.1 (佐文型号1)	PAGE	KOBAN NO.2 (佐文型号2)	PAGE	PART NO. (配件型号)	KOBAN NO. (佐文型号)	PAGE
333-D/-SK, 337-D		KHS12-S	2				SC31	24
333-LH, NF-331-LH, -951-LH, WF-955		KHS20-RM2	4				SC33-L	26
333-LH/AUT		KHS20-GTMP	4				SC33-LNS N	26
333-TD/-AUT, 337-AUT		KHS12-SP					SC31-NS N	24
DN-2220/-2242		SKRT12-5MK		KRT12-5MK			SCP-MK	23
DN-2220-AUT/-2242-AUT		SKRT12-5MC-2		KRT12-5MC			SCP-MKC	
DN-2220-LH/-2242-LH		SKRT12-5LMK	14	KRT12-5LMK	14		SCP-LMK	23
DN-2220-LH/AUT, -2242-LH/AUT		SKRT12-5LMKC-1		KRT12-5LMKC			SCP-LMKC	
LP-9225-LH-L/-R, -9226-LH		KRT8-LPS	19					

Teflon 特氟隆内釜

DLC 像鑽石一樣堅硬的石炭塗層内釜

Ti 鈦塗層

ADJ 护针片调整旋梭

N 附防止空軋彈簧片

* = EXCLUSIVE ITEMS

GLOBAL								
MACHINE (機器)	HOOK (旋梭)					BOBBIN CASE & CAP (梭壳 & 梭帽)		
	PART NO. (配件型号)	KOBAN NO.1 (佐文型号1)	PAGE	KOBAN NO.2 (佐文型号2)	PAGE	PART NO. (配件型号)	KOBAN NO. (佐文型号)	PAGE
LP-9226-LH/SNB		SKRT8-LPK with Cap	20	KRT8-LPK hook only	20		SCP-BLP	23
LP933-R/934-R/ LP9941-R/9942-R		KRT31-NR	15					
LP9915L/R, WF-975		KRT31-11SG	15					
LP9971/9974		KRT470-R	16				SCPF15	23
NF-331/-SK		KHS12-SD	2				SC82-J	25
NF-331-AUT		KHS12-SPD3	2				SC82-JNS N	25
NF-331-SK/AUT		KHS12-SPD3	2				SC82-JNS N	25
WF-1767/AUT, -1767-2		KRT467						
WF-904, -905, -905-95/ -1, ZZ-1366-3S-76P		KSP204N	18					
WF-9201-50/-9202-50		KRT14-5	17					
WF-925/-60, -926/-60		KRT12-5LMC	13					
WF-925-60/AUT, -925-AUT, -926-60/AUT, -926-AUT		KRT12-5LMKC-CI	13					
WF-926-SNB		SKRT12-5LMK with Cap	14	KRT12-5LMK hook only	14		SCP-LMK	23
WF-926-SNB/AUT		SKRT12-5LMKC-1 with Cap		KRT12-5LMKC hook only			SCP-LMKC	
WF-9335-B		KHS12-SPD3	2				SC31-NS N	24
WF-955-AUT/-TD, -995-AUT		KHS20-RMP	4				SC33-LNS N	26
WF-975-LH		SKRT341-NR with Cap	20	KRT341-NR hook only	20		SCP545	23

GOLDEN WHEEL (金輪)								
MACHINE (機器)	HOOK (旋梭)					BOBBIN CASE & CAP (梭壳 & 梭帽)		
	PART NO. (配件型号)	KOBAN NO.1 (佐文型号1)	PAGE	KOBAN NO.2 (佐文型号2)	PAGE	PART NO. (配件型号)	KOBAN NO. (佐文型号)	PAGE
CS-1100F/-5100/-5100H/ -5150S/-5200/-5850/-6000		KHS12-S	2				SC31	24
CS-1100H/-1100S/-5100-5/ -5150/-7500-5, -5100-5/H		KHS12-R	1				SC31	24
CS-243/-411/ -273/-2040/-2050		KSP204H						
CS-2401-T		SKRT470-O-R with Cap		KRT470-O-R hook only			SCPF15	23
CS-2110		KR24-T					SC35-T	24
CS-2151/-2152/ -2160/-2161/-2162		KHS20-TZ	6				SC34-L	26
CS-2390/-2391/-2392/ -2393/-2394/-2395/-2460N		KHS20-TZ	6				SC34-L	26
CS-2180		KR24U-42	9				SC35-T	24
CS-2200/-2201/-2201S/ -2202/-2202S/-2203/ -2203S/-2212S/-2213S		KRP457H					SC70-3NS N	
CS-2280		KR69-V	9				SC39-14	24
CS-8753L/-8753LV		KR69	9				SC39	24
CS-2380/-2383		KRP457JICC DLC	10	KRP457JTI Ti	10		SC70-3JNS N	27
CS-2401-T, CSR-2401-H		SKRT470-R with Cap	16	KRT470-R hook only	16		SCPF15	23

Teflon HOOK BASE TEFLON

DLC HOOK BASE DLC COATING
MINIMAL OIL

Ti HOOK BASE
TITANIUM COATING

ADJ ADJUSTABLE STRONG
NEEDLE GUARD

N WITH NON SLIP SPRING

* = EXCLUSIVE ITEMS

GOLDEN WHEEL (金輪)								
MACHINE (機器)	HOOK (旋梭)					BOBBIN CASE & CAP (梭壳 & 梭帽)		
	PART NO. (配件型号)	KOBAN NO.1 (佐文型号1)	PAGE	KOBAN NO.2 (佐文型号2)	PAGE	PART NO. (配件型号)	KOBAN NO. (佐文型号)	PAGE
CS-243/-273/-441/ -411N/-461/-471/-491		KSP204N	18					
CS-872-3/-3100-3		KRT12-5BH						
CS-3100L/-7172/-871L/ -872L/-8172,CSN-8172		KRT12-5LM	13					
CS-8163DS/-8163D/ -8183D/-8183DS		KRT842F-S	11					
CS-3101		KRT12-5B	11					
CS-3101-3		KRT842H-S	11					
CS-3101-5		KRT842H-R						
CS-3101-L/-8173/-8184D		KRT872L	13					
CS-3150/-3/-5, 875-3/-5		SKRT12-5BK with Cap	11	KRT12-5BK hook only	11		SCP-BK	23
CS-3150-L/-8176D/ -8186D/-8186D-BT		SKRT875LK with Cap		KRT875LK hook only			SCP-LBK	
CS-335BH/-335U/ -8703/-8703-V		KR24-B	8				SC35	24
CS-335L		KR335-V	9				SC335-V N	28
CS-350		KR21-R	8				SC31	24
CS-350L/-3811/-6100/ -6102/-6103/-6103N		KHS20-R	4				SC33-L	26
CS-6104/-6104N/-6120/ -6130/-6132/-6310		KHS20-R	4				SC33-L	26
CS-350L-T/-5150L-BT/ -6102BT/-6103N-BT/ -6104N-BT/-6130BT/ -6132BT		KHS20-RMP	4				SC33-LNS N	26
CS-3600, -8000-20/-25/-30		KR21-S	8				SC31	24
CS3L-7241,CSU-4101		KRT12-5LMC	13					
CS3L-7243		KRT11-5LJR	13					
CS-4150BT/-4250BT, CSU-4150BT/-4250BT		KRT12-5LMKC-CI-NS						
CS-5100-5BT/-5100-5N -BT/-5100DAN-5-BT/ -5100DHN-BT		KHS12-RP	1				SC31-NS N	24
CS-5100ADNH-BT/-5100AN -5BT/-5100ANH-BT/ -5100-H-BT/-5100HN-BT		KHS12-RP	1				SC31-NS N	24
CS-5150BT/-5850BT/ -6000-BT/-7500-5-BT		KHS12-RP	1				SC31-NS N	24
CS-5100BT/-5100D-BT/ -5100D-5N-BT/-5100DN-BT/ -5100N-BT		KHS12-SPD2	3				SC31-NS N	24
CS-5100ADN-2T/ A,-5100ADNH2T/ A,-5103ADHN-2T/A		KHS12-SPD2	3				SC31-NS N	24
CS-5103ADHN-2T/A, -5103D-BT/-5103DN-BT/ -5103-BT/-5100-5BT		KHS12-SPD2	3				SC31-NS N	24
CS-5150-BT/-5150S-BT/ -5200-BT/-5220-BT/ -5750DN-BT/-5850-BT/ -6000-BT/-7500-BT		KHS12-SPD2	3				SC31-NS N	24

Teflon 特氟隆内釜

DLC 像鑽石一樣堅硬的石炭塗層内釜

Ti 鈦塗層

ADJ 护针片調整旋梭

N 附防止空轉彈簧片

* = EXCLUSIVE ITEMS

GOLDEN WHEEL (金輪)								
MACHINE (機器)	HOOK (旋梭)					BOBBIN CASE & CAP (梭壳 & 梭帽)		
	PART NO. (配件型号)	KOBAN NO.1 (佐文型号1)	PAGE	KOBAN NO.2 (佐文型号2)	PAGE	PART NO. (配件型号)	KOBAN NO. (佐文型号)	PAGE
CS-5100BT		KHS12-SPD4	3				SC31-NS N	24
CS-5150L		KHS20-RM2	4				SC33-L	26
CS-530-100		KSP360						
CS-6111BFT/FT/T, -6112BFT/FT/T, CSA-6111T		SKRT470C-R with Cap	16	KRT470C-R hook only	16		SCPF441	23
CS-6111L-T/CSA-6112L-T		SKRT1972 with Cap ADJ		KRT1972 hook only ADJ			SCP545C	
CS-6112L-T/-8812L-M/-8812L-BT/-8822L-M, CSA-6111D-LBFT		KRT1971 ADJ						
CS-6210/-6220/-6220-B		KHS20-RP1ECC DLC	4	KHS20-RP1E			SC33-LNSH N	26
CS-7162/-S, -8162/-S, CSN-8162/-8162S		KRT12-5M	11					
CS-7162-BT/-7162S-BT/-8162BT/-8162S-BT		KRT12-5MCI-NS						
CS-7165/-S, -8165/-S		SKRT12-5MK with Cap	11	KRT12-5MK hook only	11		SCP-MK	23
CS-7165-BT/-7165S-BT/-8165BT/-8165S-BT		KRT12-5MC-NS					SCP-MKC	
CS-7172-BT/-8162-BT/-8162S-BT/-8172-BT		KRT12-5LMKCI-NS						
CS-8162-BT-1A/-2A, -8172-BT-1A/-2A		KRT12-5LMKCI-NS						
CS-8162SDM-BT/-8162DM-BT/-8172DM-BT/-8175-BT/-8175H-BT		KRT12-5LMKCI-NS						
CS-7175/-8175/-875L		SKRT12-5LMK with Cap	14	KRT12-5LMK hook only	14		SCP-LMK	23
CS-7175BT/H-BT, -8175-BT/H-BT		SKRT12-5LMKC-NS with Cap		KRT12-5LMKC-NS hook only			SCP-LMKC	
CS-7200		SKRT18-RG with Cap		KRT18-RG hook only			SCP18	
CS-7363BT/-8330BT/-8350-BT/-8332-BT/-8352-BT		KRT31-LTR						
CS-7500/-7500-BT/-7520/-7520-BT		KHS12-GTHPD	1				SC82-JNS N	25
CSH-7800		KRP41-LH2	10				SC70-771	27
CS-810/-820/-821/-822		KRT31-NR	15					
CS-5361/-5361N/-5362N/-7361/-7361N/-7362/-7362N/-7365		KRT31-NR	15					
CS-8113/-8713/-8713-V		KHS20-HPEW	4				SC33-LDH N	26
CS-8150/-519/-895/-8151~8154		SH282	21				SC980-2 N	29
CSA-3450-1/3/5, CSA-3470/-3510		SH282	21				SC980-2 N	29
CS-8150-555/558, CSA-3500		SH280	21				SC980-2 N	29
CS-872-3		KRT12-5BH						

Teflon HOOK BASE TEFLON

DLC HOOK BASE DLC COATING MINIMAL OIL

Ti HOOK BASE TITANIUM COATING

ADJ ADJUSTABLE STRONG NEEDLE GUARD

N WITH NON SLIP SPRING

* = EXCLUSIVE ITEMS

GOLDEN WHEEL (金輪)								
MACHINE (機器)	HOOK (旋梭)					BOBBIN CASE & CAP (梭壳 & 梭帽)		
	PART NO. (配件型号)	KOBAN NO.1 (佐文型号1)	PAGE	KOBAN NO.2 (佐文型号2)	PAGE	PART NO. (配件型号)	KOBAN NO. (佐文型号)	PAGE
CS-8163DS-BT/-8183D -BT/-8183DS-BT		KRT842CI	11					
CS-8173D-BT		SKRT872LC with Cap	14	KRT875LC hook only	14		SCP-LBC	23
CS-8176D-BT		SKRT875LKC with Cap	14	KRT875LC hook only	14		SCP-LBKC	23
CS-8185D		SKRT845BK with Cap	12	KRT845BK hook only	12		SCP-842BK	23
CS-8185D-BT		SKRT845KC with Cap	12	KRT842KC hook only	12		SCP-842BKC	23
CS-8233/-NR		SKRT341G with Cap	20	KRT341G hook only	20		SCP545	23
CS-8242/-8244		KRT31-11RG						
CS-8243/-8243D/ -8244L/-8244L1-K		SKRT341-NR with Cap	20	KRT341-NR hook only	20		SCP545	23
CS-8360/-8361/ -8362		SKRT470-RH with Cap	16	KRT470-RH hook only	16		SCPF15H	23
CS-8365/-8365M/ -8365H/-8366/-8366M		SKRT390-HBG with Cap	15	KRT390-HBG hook only	15		SCPF15H	23
CS-8367/-8367M/-8368/ -8900/-8901/-8902		SKRT390-HBG with Cap	15	KRT390-HBG hook only	15		SCPF15H	23
CS-861/-862/-8369/ -M/-MH/-MHR/-MR/-R		SKRT470-R with Cap	16	KRT470-R hook only	16		SCPF15	23
CS-8381/-8381R/ -8382/-8810/-8812/ -8813/-8820		SKRT470-R with Cap	16	KRT470-R hook only	16		SCPF15	23
CS-8810D/-8820D/-8810H/ -8820H/-8810D/ -8820D/-8810L/-8820L		SKRT470-R with Cap	16	KRT470-R hook only	16		SCPF15	23
CS-8381S/-8382S, -8369MHS/MHSR/ MS/ MSR/ S/ SR		SKRT31MIN with Cap	15	KRT31MIN hook only	15		SCP31MIN	23
CS-8370/-8371/-8372		SKRT8-LPK-2 with Cap		KRT8-LPK hook only			SCP26-L	
CS-8681		KRT467J ADJ	19					
CS-8703-BT		KHS12-GTPN2D2	1				SC81-2NS2 N	24
CS-8713-BT		KHS20-RMPN	4				SC33-LNS N	26
CS-8810G/-8812/ -8812L		SKRT545FG with Cap		KRT545FG hook only			SCP545	23
CS-8810H/-8820H		SKRT470-RHB with Cap	16	KRT470-RHB hook only	16		SCPF15H	23
CS-8812L-M/L-BT		KRT1971F ADJ						
CS-8830		SKRT592V2-S with Cap ADJ		KRT592V2-S hook only ADJ			SCPF572	23
CS-8830-A		SKRT592V2-R with Cap ADJ	16	KRT592V2-R hook only ADJ	16		SCPF572	23
CS-8904		KRT14-5HP	17	KRT14-5	17			
CS-3610/-8B/-8BN/ -8BNV/-8BN-K/-8BH/ -8245/-8245V		KRT31-R	15					

Teflon 特氟隆内釜

DLC 像鑽石一樣堅硬的石炭塗層内釜

Ti 鈦塗層

ADJ 护针片調整旋梭

N 附防止空轉彈簧片

* = EXCLUSIVE ITEMS

GOLDEN WHEEL (金輪)								
MACHINE (機器)	HOOK (旋梭)					BOBBIN CASE & CAP (梭壳 & 梭帽)		
	PART NO. (配件型号)	KOBAN NO.1 (佐文型号1)	PAGE	KOBAN NO.2 (佐文型号2)	PAGE	PART NO. (配件型号)	KOBAN NO. (佐文型号)	PAGE
CS-8BL/-8BLV/-8BL-1/ -8BLV-1/-28BL/-8350L		KRT8-BL	19					
CS-7363N-BT/-7364N-BT/ -7365-BT/-8812M/-8850M/		SKRT470CT-R with Cap		KRT470CT-R hook only			SCPF441	23
CSH-7830		KRP41-LH	10				SC70-2NS N	27
CSK-8105-B430-2/-3/-6		SH430-H	21				SC430 N	29
CSL-1720		SKRT12-5-19R with Cap	11	KRT12-5-19R hook only	11		SCP18	
CS-6500/-6501, CSL-1800/-1801		KRT132	17					
CSL-1810		KRT132-MT	17					
CSU-4101		KRT12-5LMC	13					
CSU-4150/-4250		KRT12-5LMC-R	13					
CSZ-3211		KHS20-RST	5				SC34-L	26
CS-3610		SKRT190 with Cap		KRT190 hook only	15		SCPF19	
CS-5150LBT/-5100DANHL -BT/6104-BT		KHS20-RPM2	5				SC33-LNS N	26
CS-6120D-BT/-6132BT/ -7500HLN-BT/-8113-BT		KHS20-RPM2	5				SC33-LNS N	26
CS-5371A/-5371N/ -5372N/-7375		KRT31-LR	19					
CS-8330/-8331/-8350/ -8903/-8907/-8908/-8908N		KRT31-LR	19					

HIGHLEAD (海菱)								
MACHINE (機器)	HOOK (旋梭)					BOBBIN CASE & CAP (梭壳 & 梭帽)		
	PART NO. (配件型号)	KOBAN NO.1 (佐文型号1)	PAGE	KOBAN NO.2 (佐文型号2)	PAGE	PART NO. (配件型号)	KOBAN NO. (佐文型号)	PAGE
GA0688-1		KSP204N	18					
GA1398-1		KSP7-31	18					
GA2388-1,2668-1/-L, 2688-1/-L,2698-1/-1T/-2T		KSP204N	18					
GC0068-1/-1D		KRP457JICC DLC	10	KRP457JTI Ti	10		SC70-3JNS N	27
GC0318-1/-1A/-1B/-1C/ -1CE/-2/-2A/-2B /-8		KHS20-RM2	4				SC33-L	26
GC0318-1H/-2H		KHS12-S	2				SC31	24
GC0318-2AD/-2ADZ		KHS20-RMP	4				SC33-LNS N	26
GC0360-1		KHS20-RM2	4				SC33-L	26
GC0388-D/-GD		KHS20-RMP	4				SC33-LNS N	26
GC0388/0398-1		KHS20-RM2	4				SC33-L	26
GC0398-1D		KHS20-GTMP	4				SC33-LNS N	26
GC0518/-H/-MC		KHS12-SD	2				SC82-J	25
GC0518-1/-B		KHS20-RM2	4				SC33-L	26
GC0518A-D3/ -MCD		KHS12-SPD2	3				SC31-NS N	24
GC0518-BD		KHS20-GTMP	4				SC33-LNS N	26
GC0518-HD		KHS12-GTHPD	1				SC31-NS N	24
GC0618/-1/-1-SC		KHS20-RM2	4				SC33-L	26
GC0618-1D1/1D2,668-D		KHS20-RMP	4				SC33-LNS N	26
GC0918-1		KHS12-S	2				SC31	24

Teflon HOOK BASE TEFLON

DLC HOOK BASE DLC COATING
MINIMAL OIL

Ti HOOK BASE
TITANIUM COATING

ADJ ADJUSTABLE STRONG
NEEDLE GUARD

N WITH NON SLIP SPRING

* = EXCLUSIVE ITEMS

HIGHLEAD (海菱)								
MACHINE (機器)	HOOK (旋梭)					BOBBIN CASE & CAP (梭壳 & 梭帽)		
	PART NO. (配件型号)	KOBAN NO.1 (佐文型号1)	PAGE	KOBAN NO.2 (佐文型号2)	PAGE	PART NO. (配件型号)	KOBAN NO. (佐文型号)	PAGE
GC0918-1D		KHS12-SPD2	3				SC31-NS N	24
GC128-B		KHS20-RM2	4				SC33-L	26
GC128-BD		KHS20-RMP	4				SC33-LNS N	26
GC128-B-D3		KHS20-GTMP	4				SC33-LNS N	26
GC128-H,188-H/-HL		KHS12-R	1				SC31	24
GC128-HD/-H-D3		KHS12-GTHPD	1				SC31-NS N	24
GC128-M		KHS12-S	2				SC31	24
GC128-MD/-M-D1/-M-D3		KHS12-SPD2	3				SC31-NS N	24
GC1870-M		KHS12-S	2				SC31	24
GC188-B/-BL		KHS20-RM2	4				SC33-L	26
GC188-M/-MC		KHS12-S	2				SC31	24
GC188-MCD/-MD/-MDZ		KHS12-SPD2	3				SC31-NS N	24
GC1918-MDZ, 1928 -MDZ, 1958-MDZ, 1988-MD/-MDZ		KHS12-SPD2	3				SC31-NS N	24
GC1998-BDZ		KHS20-RMP	4				SC33-LNS N	26
GC1998-MCDZ/-MDZ		KHS12-SPD2	3				SC31-NS N	24
GC1998-HDZ		KHS12-GTHPD	1				SC31-NS N	24
GC2008-M		KHS12-S	2				SC31	24
GC2008-MD		KHS12-SPD2	3				SC31-NS N	24
GC20518-B, 20528-B,20638		SKRT12-5LMK with Cap	14	KRT12-5LMK hook only	14		SCP-LMK	23
GC20518-BD,20528-BD/ -BD2,20588-BDZ,20638-D		SKRT12-5LMKC-1 with Cap		KRT12-5LMKC hook only			SCP-LMKC	
GC20518-BD2		KRT12-5LMKC-CI	13					
GC20518-M		KRT12-5M	11					
GC20518-MD		KRT12-5MCI						
GC20528-M		SKRT12-5MK with Cap	11	KRT12-5MK hook only	11		SCP-MK	23
GC20528-MD/-MD3,20588 -HDZ/-MDZ,20818-MD		SKRT12-5MC-2 with Cap		KRT12-5MC hook only			SCP-MKC	
GC20568-BDZ		KRT12-5LMKCI	13					
GC20568-HDZ/-MDZ		KRT12-5MCI						
GC20588-HDZ/-MDZ		SKRT12-5MC-1 with Cap		KRT12-5MC hook only			SCP-MC	
GC20618-1/-2, 20698-1/-2		KRT12-5LMC	13					
GC20618-1D/-2D		KRT12-5LMKC-CI	13					
GC20688-1/-2/-1BD/ -1D/-2D/-DC		KRT467						
GC20698-1D/-2D		KRT12-5LMKC-CI	13					
GC20698-5/-5T/-6/-6T		KRT14-5	17					
GC22618		KRT31-11SG	15					
GC22618-1B		SKRT341G with Cap	20	KRT341G hook only	20		SCP545	23
GC2358-1		KHS20-RM2	4				SC33-L	26
GC24018-1/-A		KRT31-NR	15					
GC24098-BL		KRT8-LPS	19					
GC24518-1/-2		KRT31-NR	15					
GC24608-1L/-1R/-2		KRT8-LPS	19					
GC24618-1		SKRT470-R with Cap	16	KRT470-R hook only	16		SCPF15	23

Teflon 特氟隆内釜

DLC 像鑽石一樣堅硬的石炭塗層内釜

Ti 鈦塗層

ADJ 护针片调整旋梭

N 附防止空轉彈簧片

* = EXCLUSIVE ITEMS

HIGHLEAD (海菱)

MACHINE (机器)	HOOK (旋梭)					BOBBIN CASE & CAP (梭壳 & 梭帽)		
	PART NO. (配件型号)	KOBAN NO.1 (佐文型号1)	PAGE	KOBAN NO.2 (佐文型号2)	PAGE	PART NO. (配件型号)	KOBAN NO. (佐文型号)	PAGE
GC24628-1		SKRT8-LPK with Cap	20	KRT8-LPK hook only	20		SCP-BLP	23
GC24698-1L/-1R		KRT31-11SG	15					
GC24698-BL/-BR/-2B		KRT8-LPS	19					
GC24818-1		KRT31-NR	15					
GC24896-2B		KRT8-LPS	19					
GC6-28-1		KHS12-S	2				SC31	24
GC6-28-1B		KHS20-RM2	4				SC33-L	26
GC6-28-1H		KHS12-R	1				SC31	24
GC80018		KSP204N	18					
HLK-03		SH430	21				SC430 N	29
HLK-3020(TH)		KSP204N	18					
HLV-18B		SKRT12-5LMK with Cap	14	KRT12-5LMK hook only	14		SCP-LMK	23

HIKARI (富山)

MACHINE (机器)	HOOK (旋梭)					BOBBIN CASE & CAP (梭壳 & 梭帽)		
	PART NO. (配件型号)	KOBAN NO.1 (佐文型号1)	PAGE	KOBAN NO.2 (佐文型号2)	PAGE	PART NO. (配件型号)	KOBAN NO. (佐文型号)	PAGE
8800E		KHS12-SPD2	3				SC31-NS N	24
HK2900SS		SH280	21				SC980N	29
HK2900SS		SH282	21				SC980N	29

HUANAN (华南)

MACHINE (机器)	HOOK (旋梭)					BOBBIN CASE & CAP (梭壳 & 梭帽)		
	PART NO. (配件型号)	KOBAN NO.1 (佐文型号1)	PAGE	KOBAN NO.2 (佐文型号2)	PAGE	PART NO. (配件型号)	KOBAN NO. (佐文型号)	PAGE
GC10-1H/10-1P		KHS12-R	1				SC31	24
GC10-1/10-1B/10-1S		KHS12-S	2				SC31	24
GC281/281B/281H/ 281P/281S		KHS12-S	2				SC31	24
GC28-1/28-3/28-3B/ 28-3H/28-3P/28-3S/48-1		KHS12-S	2				SC31	24
GC0301-1/0302		KHS12-SD	2				SC82-J	25
GI6/GI6-1		KRP41-LH	10				SC70-2	27
GC24010-1/GC24011-1		KRT31-R	15					
GC24301-2		SKRT470-R with Cap	16	KRT470-R hook only	16		SCPF15	23
GC20505-1		SKRT842FK-S with Cap	12	KRT842FK-S hook only	12		SCP-842BC	23

JACK (杰克)

MACHINE (机器)	HOOK (旋梭)					BOBBIN CASE & CAP (梭壳 & 梭帽)		
	PART NO. (配件型号)	KOBAN NO.1 (佐文型号1)	PAGE	KOBAN NO.2 (佐文型号2)	PAGE	PART NO. (配件型号)	KOBAN NO. (佐文型号)	PAGE
JK-457		KRP457	10				SC70-3	27
JK-58420-003		KRT842F-S	11					
JK-58420-005		KRT842H-S	11					

Teflon HOOK BASE TEFLON

DLC HOOK BASE DLC COATING
MINIMAL OIL

Ti HOOK BASE
TITANIUM COATING

ADJ ADJUSTABLE STRONG
NEEDLE GUARD

N WITH NON SLIP SPRING

* = EXCLUSIVE ITEMS

JACK (杰克)								
MACHINE (机器)	HOOK (旋梭)					BOBBIN CASE & CAP (梭壳 & 梭帽)		
	PART NO. (配件型号)	KOBAN NO.1 (佐文型号1)	PAGE	KOBAN NO.2 (佐文型号2)	PAGE	PART NO. (配件型号)	KOBAN NO. (佐文型号)	PAGE
JK-58420D/-005		SKRT842C with Cap	11	KRT842KC hook only	11		SCP-842BC	23
JK-5842-3		KRT842F-S	11					
JK-5842-5		KRT842H-S	11					
JK-5842D-3		KRT842F-S	11					
JK-5842D-5		KRT842H-S	11					
JK-58450-003/-005		SKRT845BK with Cap	12	KRT845BK hook only	12		SCP-842BK	23
JK-58450D/-003/ -005		SKRT845KC with Cap	12	KRT842KC hook only	12		SCP-842BKC	23
JK-5845-3		SKRT845BK with Cap	12	KRT845BK hook only	12		SCP-842BK	23
JK-5845-5		SKRT845KC with Cap	12	KRT842KC hook only	12		SCP-842BKC	23
JK-58720-003/-005		KRT872L	13					
JK-58720D/-003/-005		SKRT872LC with Cap	14	KRT875LC hook only	14		SCP-LBC	23
JK-5872-3		KRT872L	13					
JK-5872-5		SKRT872LC with Cap	14	KRT875LC hook only	14		SCP-LBC	23
JK-58750-003/-005		SKRT875LK with Cap		KRT875LK hook only			SCP-LBK	
JK-58750D		SKRT875LKC with Cap	14	KRT875LC hook only	14		SCP-LBKC	23
JK-58750D-003/-005		SKRT875LKC with Cap	14	KRT875LC hook only	14		SCP-LBKC	23
JK-5875-3		SKRT875LK with Cap		KRT875LK hook only			SCP-LBK	
JK-5875-5		SKRT872LC with Cap	14	KRT875LC hook only	14		SCP-LBC	23
JK-5878-58		KHS12-SPD6	3				SC31-NS N	24
JK-6318		KHS20-R	4				SC33-L	26
JK-6380D		KHS20-RMP	4				SC33-LNS N	26
JK-6691/-6692		SKRT592V2-R with Cap ADJ	16	KRT592V2-R hook only ADJ	16		SCPF572	23
JK-781		KRP41-LH2	10				SC70-771NS N	27
JK-8500		KHS12-S	2				SC31	24
JK-8500H		KHS12-GTH	1				SC31	24
JK-980-H		KHS12-SPB3OHO	2				SC31-NS N	24
JK-T10080-10-022		KHS20-SMP	5				SC33-LNS N	26
JK-T1790BS-1		KRP41-LH3ICC DLC	10				SC70-LH3NS N	27
JK-T1790S-0413		KRP41-LH3ICC DLC	10				SC70-LH3NS N	27
JK-T1790S-0416		KRP41-LH3KICC DLC	10				SC70-LH3NS N	27
JK-T1850/-1903A/ -1904AS/-1906AS		SH280	21				SC980-2 N	29
JK-T1900AS/-1906AH		SH282	21				SC980-2 N	29
A2S-CQ		KHS12-SPD2	3				SC31-NS N	24
A3-C/-CQ/-CHQ,A3-CQ-7		KHS12-SPD2	3				SC31-NS N	24
A4/C/Q/CQ/-7/C-7		KHS12-SPD2	3				SC31-NS N	24

Teflon 特氟隆内釜

DLC 像鑽石一樣堅硬的石炭塗層内釜

Ti 鈦塗層

ADJ 护针片調整旋梭

N 附防止空轉彈簧片

* = EXCLUSIVE ITEMS

JACK (杰克)

MACHINE (机器)	HOOK (旋梭)					BOBBIN CASE & CAP (梭壳 & 梭帽)		
	PART NO. (配件型号)	KOBAN NO.1 (佐文型号1)	PAGE	KOBAN NO.2 (佐文型号2)	PAGE	PART NO. (配件型号)	KOBAN NO. (佐文型号)	PAGE
A4S/S-N/S-W/S-WN		KHS12-SPD2	3				SC31-NS N	24
A5		KHS12-SPD2	3				SC31-NS N	24
A5-H/-WH/A5-H-7,R5-H/-HQ		KHS12-SPB3OHO	2				SC31-NS N	24

JAKI (佳島)

MACHINE (机器)	HOOK (旋梭)					BOBBIN CASE & CAP (梭壳 & 梭帽)		
	PART NO. (配件型号)	KOBAN NO.1 (佐文型号1)	PAGE	KOBAN NO.2 (佐文型号2)	PAGE	PART NO. (配件型号)	KOBAN NO. (佐文型号)	PAGE
JR0303D		KHS20-RMP	4				SC33-LNS N	26
JR6202D		KHS20-SMP	5				SC33-LNS N	26
JR6358QG/8700		KHS12-S	2				SC31	24
JR7200D/9200D/ 9300QGD		KHS12-SPD2	3				SC31-NS N	24
JR9800QGD/ 9801D-2/9802D-2		KHS12-SPD2	3				SC31-NS N	24
JR9200D-H/9300QGD-H/ 9800QGD-H		KHS12-RP	1				SC31-NS N	24

JANOME (真善美)

MACHINE (机器)	HOOK (旋梭)					BOBBIN CASE & CAP (梭壳 & 梭帽)		
	PART NO. (配件型号)	KOBAN NO.1 (佐文型号1)	PAGE	KOBAN NO.2 (佐文型号2)	PAGE	PART NO. (配件型号)	KOBAN NO. (佐文型号)	PAGE
DB-J701/-J702/-J703	701505004	KHS12-S	2			761511009	SC31	24
DB-J704/-J707/-J708	701505004	KHS12-S	2			761511009	SC31	24
DB-J705/-J706	703504009	KHS12-R	1			761511009	SC31	24
DB-J706S	706505009	KHS20-R	4			706506000	SC33-L	26
TA-J761/-J763/-J766	761510008	KR21-G	8			761511009	SC31	24

JUITA (川田)

MACHINE (机器)	HOOK (旋梭)					BOBBIN CASE & CAP (梭壳 & 梭帽)		
	PART NO. (配件型号)	KOBAN NO.1 (佐文型号1)	PAGE	KOBAN NO.2 (佐文型号2)	PAGE	PART NO. (配件型号)	KOBAN NO. (佐文型号)	PAGE
9000A-3D/JTVF-2		KHS12-SPD2	3				SC31-NS N	24
9000A-3DFH/ JT911D-02A/JTVF-2H		KHS12-RP	1				SC31-NS N	24
JTK8-9AH/K9-50~90		KHS20-SP3E-O2					SC33-LNS N	26
K7-50~90		KHS20-RMP	4				SC33-LNS N	26
K8-50~90		KHS20-SMP	5				SC33-LNS N	26

JUKI (重机)

MACHINE (机器)	HOOK (旋梭)					BOBBIN CASE & CAP (梭壳 & 梭帽)		
	PART NO. (配件型号)	KOBAN NO.1 (佐文型号1)	PAGE	KOBAN NO.2 (佐文型号2)	PAGE	PART NO. (配件型号)	KOBAN NO. (佐文型号)	PAGE
AB-1351, -1360, -1360/CR-10A	40110846	SH280	21			B18289800BB	SC980-2 N	29
AE-200ALA, -200ALD	11038650*	KHS12-SPOED2*		KHS12-SPD2	3	B1837555BAA/11038759	SC31-NS N	24
AMS-205C, -206C	B1818280000/26204909	SH280	21			B18289800BB	SC980-2 N	29

Teflon HOOK BASE TEFLON

DLC HOOK BASE DLC COATING
MINIMAL OIL

Ti HOOK BASE
TITANIUM COATING

ADJ ADJUSTABLE STRONG
NEEDLE GUARD

N WITH NON SLIP SPRING

* = EXCLUSIVE ITEMS

JUKI (重机)								
MACHINE (机器)	HOOK (旋梭)					BOBBIN CASE & CAP (梭壳 & 梭帽)		
	PART NO. (配件型号)	KOBAN NO.1 (佐文型号1)	PAGE	KOBAN NO.2 (佐文型号2)	PAGE	PART NO. (配件型号)	KOBAN NO. (佐文型号)	PAGE
AMS-205C, -206C, -210B/ C, -211C/P, -212C, -215C/ P, -220B/C/CSS/P, -222B, -223C/CS, -224C/CS	B1818205000*	SH205*				B18282050A0*	SC205 N *	
AMS-205C, -206C, -215C/CHS, -215P, -223C/CH, -224C/CH	B1818205A0B*	SH205H2*				B18282050AA*	SC205H N *	
AMS-205CHS, -206CHS	D18289800BB	SH282	21			B18289800BB	SC980-2 N	29
AMS-210D, -215C/ D/P, -220C/P, -221D, -223C, -224C	B1818215P00*	SH215*				B1828215PA0*	SC215 N *	
AMS-210D, -215D, -221D	B1818210D0B*	SH180JB*				B1828210DAA*	SC180JHABK N *	
AMS-210D, -215D, -221D	B1818210D0A*	SH180JA*				B1828210DAA*	SC180JHABK N *	
AMS-210E/EN SERIES, -221E/EN SERIES	40014964*	SH180JAH*				B1828210DAA*	SC180JHABK N *	
AMS-210E/EN SERIES, -221E/EN SERIES	40014965*	SH180JH*				B1828210DAA*	SC180JHABK N *	
AMS-210E/EN SERIES, -221E/EN SERIES, AMS -224E/EN SERIES	40061991*	SH180JCH*				B1828210DAA*	SC180JHABK N *	
AMS-211CGS, -215C/ CGS/P, -220C/CGS/ CGB/P, -222BG, CG, -223C, -224C/CG	B1818210000*	SH180J*				B18282100A0*	SC180J N *	
AMS-224EN-HS4530R/ -HB4530R/-GS4530R/ -GB4530R/-HS4530R/AW3/ -HB4530R/AW3/-GS4530R/ AW3/-GB4530R/AW3/ -HS6030R/AW3/-HB6030R/ AW3/-GS6030R/AW3/ -GB6030R/AW3(太糸用 =FOR THICK THREAD)	40220994	KHS20-RP1EKS	4			D1837145EAA	SC33-LNSH N	26
DDL-127, 5530N, -5550, -5550N, -8700	B18301270A0*	KHS12-SJ2*		KHS12-2S	1	B18370120A0	SC31	24
DDL-201	B18302010A0	KHS20-GTB	4			B1837201SA0	SC33-LNS N	26
DDL-201S	B1830201SA0	KHS20-R2E	4			B18372010A0	SC33-L	26
DDL-5530, -5550-6, -5490-6	11038650*	KHS12-SPOED2*		KHS12-SPD2	3	11038759	SC31-NS N	24
DDL-5530NH/NL, -5550NH, -8100E, -8300H, -8500H, -8700H	11092459*	KHS12-SJ2H*		KHS12-SJH		11038759	SC31-NS N	24
DDL-5550H-6/N/N-7, -5571N-H/N-M, -5580N/ NH/NM, -5581N/NM, -8500-7, -8700-7/B-7, -9000/A/B/C-F/C-S	11092251*	KHS12-SPOED2H*		KHS12-SPD2H		11038759	SC31-NS N	24
DDL-5556N/N-WB, -5570, -5570N, -5570-N7, -5570M, -5571N, -5571NM, -5580N, -5581N	11038650/ D1830555BA0*	KHS12-SPOED2*		KHS12-SPD2	3	D1837555BAA	SC31-NS N	24
DDL-555H-4-5, -5580H	D1830415BAH	KHS12-GTHPD	1			B1837415DAL	SC82-JNS N	25
DDL-5600NJ/NU/NL/NR	B18302010A0	KHS20-GTB	4			B1837201SA0	SC33-LNS N	26
DDL-8000AP-MS	11038650/40221402*	KHS12-SPOED2*		KHS12-SPD2	3	11038759	SC31-NS N	24

Teflon 特氟隆内釜

DLC 像鑽石一樣堅硬的石炭塗層内釜

Ti 鈦塗層

ADJ 护针片調整旋梭

N 附防止空轉彈簧片

* = EXCLUSIVE ITEMS

JUKI (重机)

MACHINE (机器)	HOOK (旋梭)					BOBBIN CASE & CAP (梭壳 & 梭帽)		
	PART NO. (配件型号)	KOBAN NO.1 (佐文型号1)	PAGE	KOBAN NO.2 (佐文型号2)	PAGE	PART NO. (配件型号)	KOBAN NO. (佐文型号)	PAGE
DDL-8000AP-MS	11141355*	KHS12-SPOENPD2*		KHS12-SPD2	3	11038759	SC31-NS N	24
DDL-8000AP-SH	11092251/40221403*	KHS12-SPOED2H*		KHS12-SPD2H		11038759	SC31-NS N	24
DDL-8100E, -8300, -8500	B18301270A0/40106200*	KHS12-SJ2*		KHS12-2S	1	B18370120A0	SC31	24
DDL-8500-7, -8700-7	11038650*	KHS12-SPOED2*		KHS12-SPD2	3	D1837555BAA	SC31-NS N	24
DDL-8700	11062759	KHS12-R	1			B18370120A0	SC31	24
DDL-9000A, -9000B-MA/ -MS/SS, -9000C-F/ C-S, -900A/B/BB	11038650*	KHS12-SPOED2*		KHS12-SPD2	3	B1837555BAA/ 11038759	SC31-NS N	24
DDL-9000A, -9000B-SH	11092251*	KHS12-SPOED2H*		KHS12-SPD2H		B1837555BAA/ 11038759	SC31-NS N	24
DDL-9000A, -9000B-SS	11141355*	KHS12-SPOENPD2*		KHS12-SPD2	3	B1837555BAA/11038759	SC31-NS N	24
DLD-432, -5430N	B18301270A0*	KHS12-SJ2*		KHS12-2S	1	B18370120A0	SC31	24
DLD-5430N-7, DLN-9010/A/SS	11141355*	KHS12-SPOENPD2*		KHS12-SPD2	3	B1837555BAA/ 11038759	SC31-NS N	24
	11038650*	KHS12-SPOED2*		KHS12-SPD2	3	B1837555BAA/ 11038759	SC31-NS N	24
DLM-5200, -5200N, -5210N	B18301270A0*	KHS12-SJ2*		KHS12-2S	1	B18370120A0	SC31	24
DLM-5400N-7, 5410N-7, -5420N-7	11038650*	KHS12-SPOED2*		KHS12-SPD2	3	B1837555BAA/ 11038759	SC31-NS N	24
DLM-5400N-7, -5420N-7	11141355*	KHS12-SPOENPD2*		KHS12-SPD2	3	B1837555BAA/ 11038759	SC31-NS N	24
DLN-5410 SERIES, -5410N SERIES	B18304150A0	KHS12-SD	2			B18370120A0	SC31	24
DLU-5490N	B18301270A0*	KHS12-SJ2*		KHS12-2S	1	B18370120A0	SC31	24
DLU-5490N-7/-5494N-7	11141355*	KHS12-SPOENPD2*		KHS12-SPD2	3	B1837555BAA/11038759	SC31-NS N	24
	11038650*	KHS12-SPOED2*		KHS12-SPD2	3	B1837555BAA/11038759	SC31-NS N	24
DMN-531-5, -5420N-7	11038650*	KHS12-SPOED2*		KHS12-SPD2	3	B1837555BAA/11038759	SC31-NS N	24
	11141355*	KHS12-SPOENPD2*		KHS12-SPD2	3	B1837555BAA/11038759	SC31-NS N	24
DNU-1541-7	D1830241EA0	KHS20-RMPNW	4			B1837241H00	SC33-LD N	26
DNU-241H, -261H, -1541	B1830241HA0	KHS20-HPEW	4			B1837241H00	SC33-LD N	26
DNU-241HS, -1541S	B1830241SA0	KHS20-RPEM2AO	5			B1837241S00	SC33-LD N	26
DSC-244/-4/-6, -244V/-4/-6	21209952	KHS12-GTPN2D2	1			21210059	SC81-2NS2 N	24
	B18302450A0	KHS12-GTPND2	1			B18372450A0	SC82-JNS2 N	25
DSC-245-4/-5/-6	B18302450A0	KHS12-GTPND2	1			B18372450A0	SC82-JNS2 N	25
DSC-246/-4/-6, DSC- 246V/-4/-6	D1830141EA0	KHS20-RMPN	4			D1837141EA0	SC33-LNS3 N	26
	B1830241HA0	KHS20-HPEW	4			B1837241H00	SC33-LD N	26
	B1830141HA0	KHS20-RM3	4			B18372010A0	SC33-L	26
DSU-144/-4/-7, -145-4/-7	B1830141EA0	KHS20-RMPN	4			D1837141EA0	SC33-LNS3 N	26
DSU-144N	B1830201SA0	KHS20-R2E	4			B18372010A0	SC33-L	26
DU-1181N/**A	40098685/40032702/ B1830141HA0	KHS20-RM3	4			40021609/40098684/ 40098959	SC31-L	26
DU-140	21251053	KHS12-R	1			B18370120A0	SC31	24
DU-141H-7	D1830141EA0	KHS20-RMPN	4			21271556	SC33-LNS3 N	26
LBH-1792K	13782065*	KRP791*				13729769	SC70-LH3NS N	27
LBH-761, -762, -763	B18087610AB	KRP41-LH	10			B18107610A0	SC70-2	27
LBH-771, -772, -773, -781, -782, -783, -784	B18087710AC*	KRP771*		KRP41-LH2	10	B18107710BA/ B18107710A0	SC70-771NS N	27

Teflon HOOK BASE TEFLON

DLC HOOK BASE DLC COATING
MINIMAL OIL

Ti HOOK BASE
TITANIUM COATING

ADJ ADJUSTABLE STRONG
NEEDLE GUARD

N WITH NON SLIP SPRING

* = EXCLUSIVE ITEMS

JUKI (重机)								
MACHINE (机器)	HOOK (旋梭)					BOBBIN CASE & CAP (梭壳 & 梭帽)		
	PART NO. (配件型号)	KOBAN NO.1 (佐文型号1)	PAGE	KOBAN NO.2 (佐文型号2)	PAGE	PART NO. (配件型号)	KOBAN NO. (佐文型号)	PAGE
LBH-791~794, -791S~794S, -1790A/AB/AN/ANB/S, -1795A/AN, -1796A/AN	13729066*	KRP791*				13729769	SC70-LH3NS N	27
LG-57, -158/-1, LG-158-1U, -158U	40032438/ B1830057SA0	KRT14-5HP	17					
LH-1150	10197655	KRT12-5JI	11					
LH-1150, -1152	10110104	SKRT12-5J with Cap		KRT12-5J hook only		10110252	SCP-JC	
LH-1150/-4/-5/-6	10110062	SKRT12-5JC with Cap		KRT12-5JC hook only		10110252	SCP-JC	
LH-1152	10197655	KRT12-5JI	11					
LH-1152-4/-5/-6	10195154	KRT12-5JCI	11					
LH-1160, -1162	10208064	SKRT12-5JK-R1 with Cap		KRT12-5JK-R hook only		10208254	SCP-JKC	
	10207967	SKRT12-5JK-L1 with Cap		KRT12-5JK-L hook only		10208254	SCP-JKC	
LH-1160-4/-5/-6, -1162-4/-5/-6	10207868	SKRT12-5JKC-R1 with Cap		KRT12-5JKC-R hook only		10208254	SCP-JKC	
	10207769	SKRT12-5JKC-L1 with Cap		KRT12-5JKC-L hook only		10208254	SCP-JKC	
LH-1172	10353761	SKRT11-5LLJ-R with Cap		KRT11-5LLJ-R hook only		10353555	SCP-LLJ	
	10353860	SKRT11-5LLJ-L with Cap		KRT11-5LLJ-L hook only		10353555	SCP-LLJ	
LH-1172-4/-5/-6	10353068	SKRT11-5LLJC-R with Cap		KRT11-5LLJC-R hook only		10353555	SCP-LLJ	
	10353167	SKRT11-5LLJC-L with Cap		KRT11-5LLJC-L hook only		10353555	SCP-LLJ	
LH-1178/-6	10697084	KRT2182I						
LH-1180, -1182	10233062	SKRT12-5LJK2-R1 with Cap		KRT12-5LJK2-R hook only		10353553	SCP-LJKC	
	10232965	SKRT12-5LJK2-L1 with Cap		KRT12-5LJK2-L hook only		10353553	SCP-LJKC	
LH-1180-4/-5/-6, -1182/4/-5/-6	10231165	SKRT12-5LJKC-R1 with Cap		KRT12-5LJKC-R hook only		10353553	SCP-LJKC	
	10231066	SKRT12-5LJKC-L1 with Cap		KRT12-5LJKC-L hook only		10353553	SCP-LJKC	
LH-2172/-6	10612752*	SKRT2172F with Cap*		KRT2172F hook only*		10612554	SCP2172	
LH-3120A/AF, -3128	22612055	KRT842F-S	11					
LH-3128	22612758	SKRT842FK-S with Cap		KRT842FK-S hook only		22612659	SCP-842BC	23
LH-3128-7, -3168-7	22653158	KRT30JCI	11					
LH-3128-7,-3162-4/-7, -3168/-7	22693857	SKRT30JKC with Cap		KRT30JC hook only		22688154	SCP-842BK	23
LH-3168/-7	22688253	SKRT845BK with Cap	12	KRT845BK hook only	12	22688154	SCP-842BK	23
LH-3178, -3188	22827158	SKRT30LJK with Cap		KRT30LJK hook only		22827257	SCP-LBKC(J)	
	22813455	KRT872L	13					
LH-3178, -3188/-7	22814255	SKRT30LJ with Cap		KRT30LJ hook only		22819650	SCP-LBC(J)	

Teflon 特氟隆内釜

DLC 像鑽石一樣堅硬的石炭塗層内釜

Ti 鈦塗層

ADJ 护针片調整旋梭

N 附防止空轉彈簧片

* = EXCLUSIVE ITEMS

JUKI (重机)

MACHINE (机器)	HOOK (旋梭)					BOBBIN CASE & CAP (梭壳 & 梭帽)		
	PART NO. (配件型号)	KOBAN NO.1 (佐文型号1)	PAGE	KOBAN NO.2 (佐文型号2)	PAGE	PART NO. (配件型号)	KOBAN NO. (佐文型号)	PAGE
LH-3178-7, 3188-7	22831259	SKRT30LJKC with Cap		KRT30LJC hook only		22827257	SCP-LBKC(J)	
	22819452	SKRT30LJC with Cap		KRT30LJC hook only		22819650	SCP-LBC(J)	
LH-3500 SERIES	40036684*	SKRT35JK with Cap*		KRT35JK hook only*		22688154	SCP35JKC	
	40036682*	KRT35Jl*						
LH-3528A	40091143*	KRT35AJl*						
LH-3528A-7	40036683*	KRT35JCl*						
LH-3568A	40091144*	SKRT35AJK with Cap*		KRT35AJK hook only*		22688154	SCP35JKC	
LH-3568A-7	40036685*	SKRT35JKC with Cap*		KRT35JKC hook only*		22688154	SCP35JKC	
LH-3578A	40043333*	KRT35Jl*						
LH-3578A-7	40043334*	KRT35LJCl*						
LH-3588A	40043335*	SKRT35LJK with Cap*		KRT35LJK hook only*		22827257	SCP-LBKC(J)	
LH-3588A-7	40043336*	SKRT35LJKC with Cap*		KRT35LJKC hook only*		22827257	SCP-LBKC(J)	
LH-4128/-7	40013786*	KRT40JCl*						
LH-4168-7	40025164*	SKRT40JKC with Cap*		KRT40JC hook only*		40060555	SCP40JKC	
LH-4188-7	40018976*	SKRT35LJKC with Cap*		KRT35LJKC hook only*		22827257	SCP-LBKC(J)	
LH-4500C SERIES	40242130*	SKRT45LJKCV-S with Cap* ADJ		KRT45LJKCV-S hook only* ADJ		40242602*	SCP45LJKC*	
	40220167*	SKRT45LJGKCV-S with Cap* ADJ		KRT45LJGKCV-S hook only* ADJ		40240709*	SCP45LJGKC*	
	40246970*	KRT45LJIV-S* ADJ						
	40220166*	KRT45LJGCIV-S* ADJ						
	40220171*	KRT45LJFIV-S* ADJ						
	40242190*	KRT45LJCIV-S* ADJ						
LH-512, -515	B18305120A0	KRT21	15					
LH-512H, -515H	B18305120AH	KRT21-R	15					
LH-527	B18305210A0	SKRT11-5LJKS with Cap	14	KRT11-5LJKS hook only	14	B18375260A0	SCP-LJK	
LH-528	B18305280A0	SKRT21-K with Cap		KRT21-K hook only		B18375280A0	SCP-MK	23
LK-1850/C, -1851/C	B181828000A	SH280Ti				B18289800A0	SC980N	29
LK-1850/C, -185/C, -1900	B1818280000/26204909	SH280	21			B18289800A0	SC980N	29
LK-1900A/AHS	40006581*	SH282H*		SH282	21	B18289800BB	SC980-2 N	29
	40006580*	SH280H*		SH280	21	B18289800BB	SC980-2 N	29
LK-1900A/AN SERIES, LK-1900B/BN SERIES	40014965*	SH180JH*				B1828210DAA*	SC180JHABK* N	
LK-1900A-HS/B-HS/BN- HS, -1900B-HS/X73186, -1902B-HS/BN-HS	40112995	SH282	21			B18289800BB	SC980-2 N	29
LK-1900A-SS/B-BF/ B-BS/B-FS/B-MS/ B-SS/BN-BF/BN-BS/ BN-FS/BN-MS/BN-SS	40110846	SH280	21			B18289800BB	SC980-2 N	29

Teflon HOOK BASE TEFLON

DLC HOOK BASE DLC COATING
MINIMAL OIL

Ti HOOK BASE
TITANIUM COATING

ADJ ADJUSTABLE STRONG
NEEDLE GUARD

N WITH NON SLIP SPRING

* = EXCLUSIVE ITEMS

JUKI (重机)								
MACHINE (机器)	HOOK (旋梭)					BOBBIN CASE & CAP (梭壳 & 梭帽)		
	PART NO. (配件型号)	KOBAN NO.1 (佐文型号1)	PAGE	KOBAN NO.2 (佐文型号2)	PAGE	PART NO. (配件型号)	KOBAN NO. (佐文型号)	PAGE
LK-1901BN-SS/B-SS, -1902BN-SS/B-SS, -1903B/BB, -1903B/BR35	40110846	SH280	21			B18289800BB	SC980-2 N	29
LK-1910, -1920, -1930	B1818210D0B*	SH180JB*				B1828210DAA*	SC180JHABK* N	
	B1818210D0A*	SH180JA*				B1828210DAA*	SC180JHABK* N	
LK-1952, -1953, -1954	13876305*	SH180J2*				B18282100A0*	SC180J* N	
LK-232	B1823232000	SH232	21			B18289800A0	SC980N	29
LK-280, -980	B1818280000/ 26204909	SH280	21			B18289800A0	SC980N	29
LK-282, -1850J, -1851, -1900	D1818282N00/ B1818282000	SH282	21			B18289800A0	SC980N	29
LS-1340	B18013400A0	KRT31-11SG	15					
LS-1341	21431358	SKRT341-NS with Cap		KRT341-NS hook only		21431606	SCP545	23
LS-1342-7	21441753	KRT342-NCI-S						
	21435854	KRT342-NCI-R						
LS-2342	40161345*	KRT342-N2I-R*						
LS-2342-7	40162678*	KRT342-N2CI-R*						
LS-311	B18303110A0	KRT341GI						
LS-321	21245055	SKRT341SG with Cap		KRT341SG hook only		21229356	SCP545	23
	21228051	SKRT341G with Cap	20	KRT341G hook only	20	21229356	SCP545	23
LS-341N, -341N-7, -1341	21229752	SKRT341-NR with Cap	20	KRT341-NR hook only	20	21229307	SCP545	23
LU-1114-4/-5/-6/-7	10353068	SKRT11-5LLJC-R with Cap		KRT11-5LLJC-R hook only		10353555	SCP-LLJ	
	10353076	KRT11-5LLJCI-R	13					
LU-1508/N/NS, -1509N, -1510/N, -1560/N, -1561N	B18305630A0	KRT11-5LJS	13					
LU-1508H/NH, -1509NH	B1830563BA0	KRT11-5LJR	13					
LU-1509N-7, -1510N-7, -1511N-7, -1560N-7, 1561N-7, -1565N	21387055*	KRT150LJCI-R*						
LU-1510N-7, -1510NA-7	40079022*	KRT150LJCIV-S* ADJ		KRT150LJC2ICC-S DLC				
LU-1510N-7/NA-7, -1560N/ N-7, 1561N/N-7	40095613*	KRT11-5LJV-S* ADJ						
LU-1520NCS-7	40210517*	KRT11-5LJCI2V-S* ADJ						
LU-1565N	B18305210A0	SKRT11-5LJKS with Cap	14	KRT11-5LJKS hook only	14	B18375260A0	SCP-LJK	
LU-2210N-7, -2212N-7, -2216N-7, -2220N-7, -2260N-7, 2266N-7	10761252/40075390	KRT467J ADJ	19					
LU-2800 SERIES, -2810ES-7, -2818ES-7	40147985*	KRT280XLJCIV2-R* ADJ						
LU-2800 SERIES, -2810ES -7, -2818ES-7, -2860V-7	40131956/40142204*	KRT280LJCIV-R* ADJ						
LU-2800 SERIES	40126399/40142203*	KRT280LJIV-R* ADJ						
LU-2828-6/-7/ES-7/V-7	40147912*	KRT280XLJCIV-R* ADJ						
LU-2828V-7	40195292*	KRT280XLJCIV-R* ADJ						

Teflon 特氟隆内釜

DLC 像鑽石一樣堅硬的石炭塗層内釜

Ti 鈦塗層

ADJ 护针片调整旋梭

N 附防止空轉彈簧片

* = EXCLUSIVE ITEMS

JUKI (重机)

MACHINE (机器)	HOOK (旋梭)					BOBBIN CASE & CAP (梭壳 & 梭帽)		
	PART NO. (配件型号)	KOBAN NO.1 (佐文型号1)	PAGE	KOBAN NO.2 (佐文型号2)	PAGE	PART NO. (配件型号)	KOBAN NO. (佐文型号)	PAGE
LU-2860V-7	40175675/40199461*	KRT280LAJCV-R* ADJ						
LU-562N, -563N	B18305630A0	KRT11-5LJS	13					
LU-563-3	B1830563BA0	KRT11-5LJR	13					
LUH-521	B1830521HA0	SKRT11-5LJKR with Cap		KRT11-5LJKR hook only		B18375210A0	SCP-LJ	
LUH-526	B18305210A0	SKRT11-5LJKS with Cap	14	KRT11-5LJKS hook only	14	B18375260A0	SCP-LJK	
LZ2280 SERIES	22525059/40161000*	KRP41-LZJV* Ti		KRP457JTI Ti / KRP457JICC DLC	10	40003598	SC70-3JNS N	27
LZ2280A/NU, -2282N, -2284A/A-7/C-7/N-7/NU/ NU-7, -2285N, -2286N, -2287A	22525877/40161000*	KRP41-LZJV* Ti		KRP457JTI Ti / KRP457JICC DLC	10	23537459	SC70-3JNS N	27
LZ2290A-SR/A-SS/ A-SU/CF-7/CS/CS-7	22525877/40161000*	KRP41-LZJV* Ti		KRP457JTI Ti / KRP457JICC DLC	10	23537459	SC70-3JNS N	27
LZ-271	B18300270A0	KR23-16-2				B18370270A0	SC35	24
LZ-391, -391N	B18307100A0	KR23-16	8			B18370270A0	SC35	24
LZ-581~586	B18305810A0	KHS11S-58	7			B18375820A0	SC35-NS N	24
LZH-1290/-4/-6	10078954	KHS20-RT	5			10080059	SC34-LZNS N	26
MC592, MC676	B1818210D0A*	SH180JA*				B1828210DAA*	SC180JHABK* N	
MC592, MC676	B1818210D0B*	SH180JB*				B1828210DAA*	SC180JHABK* N	
MOL-254	B1818210D0B*	SH180JB*				B1828210DAA*	SC180JHABK* N	
PLC-1710, -1760	40039010	KRT170LJI-S	19					
PLC-1710-7, -1760-7	40038731	KRT170LJCI-S	19					
PLC-1760	23058555	KRT170LJI-R						
PLC-1760L	40038870*	SKRT170LJ-S with Cap*		KRT170LJ-S hook only*		40038869	SCP545PH	
PLC-2700 SERIES	40126399/40142203*	KRT280LJIV-R* ADJ						
PLC-2700 SERIES	40134795*	SKRT280LJKV-R with Cap* ADJ		KRT280LJKV-R hook only* ADJ		40148047*	SCP280LJK*	
PLC-2700 SERIES	40130034*	KRT280PLJCV-R* ADJ						
PLC-2700V SERIES	40211572*	KRT280PLJCI2V-R* ADJ						
PLH-981,-982,-985,-986	21010251	KRT31-NR	15					
PLW-1245/-4/-6, -1246/-4/-6	10549855	SKRT470C-R with Cap	16	KRT470C-R hook only	16	10545358	SCPF441	23
PLW-1246	10522852	SKRT470-R with Cap	16	KRT470-R hook only	16	10547651	SCPF15	23
TNU-243U, TSC -441U, -461U	21041850	KSP204N	18					
TSH-411U, -421U, -471U	21041850	KSP204N	18					
TU-273U	21041850	KSP204N	18					

Teflon HOOK BASE TEFLON

DLC HOOK BASE DLC COATING
MINIMAL OIL

Ti HOOK BASE
TITANIUM COATING

ADJ ADJUSTABLE STRONG
NEEDLE GUARD

N WITH NON SLIP SPRING

* = EXCLUSIVE ITEMS

JUMBO KING (象王)								
MACHINE (机器)	HOOK (旋梭)					BOBBIN CASE & CAP (梭壳 & 梭帽)		
	PART NO. (配件型号)	KOBAN NO.1 (佐文型号1)	PAGE	KOBAN NO.2 (佐文型号2)	PAGE	PART NO. (配件型号)	KOBAN NO. (佐文型号)	PAGE
WR-1130		KHS12-R	1				SC31	24
WR-3811		KHS20-R	4				SC33-L	26
WR-5705		KHS20-R	4				SC33-L	26
WR-3750		KHS20-RM2	4				SC33-L	26
WR-3750T		KHS20-RMP	4				SC33-LNS N	26
WR-1125N		KHS20-RST	5				SC34-LNS N	26
WR-335-901-X2/-335AX2		KHS20-TZ	6				SC34-L	26
WR-652		KR24-B	8				SC34-1	24
WR-652-901		KR24-B	8				SC35	24
WR-335A/-335B/-3358B/ -3358BL/-335-901		KR24-RHPD	8				SC34-1	24
WR-842-5		KRT12-5M	11					
WR-315-7S		KRT1971						
WR-971-T		KRT1971						
WR-972-T		KRT1971						
WR-810/-820/-830		KRT31-NR	15					
WR-830P/-840/-840P		KRT31-NR	15					
WR-467		KRT467						
WR-983-MX2BTSEF		KRT470LCI-R	19					
WR-991-332-X2		KRT470LCI-R	19					
WR-991-X2TS		KRT470LCI-R	19					
WR-992-X2TS		KRT470LCI-R	19					
WR-981-X2/-MX2/-NX2		KRT470LI-R						
WR-991-244-X2		KRT470LI-R						
WR-991-X2		KRT470LI-R						
WR-992-X2		KRT470LI-R						
WR-9950MBTS3EF		KRT470LI-R						
WR-981-MX2BTSE, -NX2TS*		KRT470LTCI-R*		KRT470LCI-R				
WR-982/-MX2BTS/ -NX2BTS/-NX2TS*		KRT470LTCI-R*		KRT470LCI-R				
WR-991-332-X2Z*		KRT470LTCI-R*						
WR-204		KSP204	18					
WR-204-370/-205/-205-370		KSP204N	18					
WR-341		SKRT341G with Cap	20	KRT341G hook only	20		SCP545	23
WR-981-BT/-BTS/-MBT/ -MBTS/-MT/-MTS/-NBT/ -NBTS/-NT/-NTS/-T/-TS		SKRT470C2-R with Cap	16	KRT470C2-R hook only	16		SCPF441	23
WR-982-BT/-BTS/-MBT/ -MBTS/-MT/-MTS/-NBT/ -NBTS/-NT/-NTS/-T/-TS		SKRT470C2-R with Cap	16	KRT470C2-R hook only	16		SCPF441	23
WR-9910-BT		SKRT470C2-R with Cap	16	KRT470C2-R hook only	16		SCPF441	23
WR-9920-BT		SKRT470C2-R with Cap	16	KRT470C2-R hook only	16		SCPF441	23
WR-991-332		SKRT470C2-R with Cap	16	KRT470C2-R hook only	16		SCPF441	23
WR-991-T/-TS		SKRT470C2-R with Cap	16	KRT470C2-R hook only	16		SCPF441	23
WR-992-T/-TS		SKRT470C2-R with Cap	16	KRT470C2-R hook only	16		SCPF441	23

Teflon 特氟隆内釜

DLC 像鑽石一樣堅硬的石炭塗層内釜

Ti 鈦塗層

ADJ 护针片调整旋梭

N 附防止空轉彈簧片

* = EXCLUSIVE ITEMS

JUMBO KING (象王)								
MACHINE (机器)	HOOK (旋梭)					BOBBIN CASE & CAP (梭壳 & 梭帽)		
	PART NO. (配件型号)	KOBAN NO.1 (佐文型号1)	PAGE	KOBAN NO.2 (佐文型号2)	PAGE	PART NO. (配件型号)	KOBAN NO. (佐文型号)	PAGE
WR-961-DN/-DR		SKRT470-R with Cap	16	KRT470-R hook only	16		SCPF15	23
WR-962-DN/-DR		SKRT470-R with Cap	16	KRT470-R hook only	16		SCPF15	23
WR-983-MBTS3EF		SKRT470-R with Cap	16	KRT470-R hook only	16		SCPF15	23
WR-991/-992		SKRT470-R with Cap	16	KRT470-R hook only	16		SCPF15	23
WR-9910-1/-9918-1/ -9920-1		SKRT470-R with Cap	16	KRT470-R hook only	16		SCPF15	23
WR-998-A/-B/-C/-D		SKRT470-R with Cap	16	KRT470-R hook only	16		SCPF15	23
WR-9910-B/-9920-B		SKRT470-R with Cap	16	KRT470-R hook only	16		SCPF15	23
WR-991-244-HB/ -9910-H/-9920-H		SKRT470-RHH with Cap		KRT470-RH hook only			SCPF441H	
WR-9910-H		SKRT470-RHH with Cap		KRT470-RH hook only			SCPF441H	
WR-9920-H		SKRT470-RHH with Cap		KRT470-RH hook only			SCPF441H	
WR-998-244-S/ -CS/-DS		SKRT47MIN with Cap	16	KRT47MIN hook only	16		SCP31MIN	23
WR-998-244-1		SKRT47MIN2 with Cap		KRT47MIN2 hook only			SCP31MIN	23
WR-982-244-T		SKRT59MIN2 with Cap		KRT59MIN2 hook only			SCP59MIN	

KAISER (凱瑟)								
MACHINE (机器)	HOOK (旋梭)					BOBBIN CASE & CAP (梭壳 & 梭帽)		
	PART NO. (配件型号)	KOBAN NO.1 (佐文型号1)	PAGE	KOBAN NO.2 (佐文型号2)	PAGE	PART NO. (配件型号)	KOBAN NO. (佐文型号)	PAGE
335	91-060 581-91 W/BC	KR335-V	9				SC335-V N	28
1243/1244/1245/1246	91-140 539-91	SKRT1242-R with Cap	19	KRT1242-R hook only	19		SCP545	23
570/590/1591/3834	91-263 490-91	SKRT592V2-S with Cap ADJ		KRT592V2-S hook only ADJ			SCPF572	23
570/590/1591	91-263 495-91	SKRT592V2-R with Cap ADJ	16	KRT592V2-R hook only ADJ	16		SCPF572	23

K-CHANCE (高機)								
MACHINE (机器)	HOOK (旋梭)					BOBBIN CASE & CAP (梭壳 & 梭帽)		
	PART NO. (配件型号)	KOBAN NO.1 (佐文型号1)	PAGE	KOBAN NO.2 (佐文型号2)	PAGE	PART NO. (配件型号)	KOBAN NO. (佐文型号)	PAGE
KBH-780		KRP41-LH2	10				SC70-771	27

Teflon HOOK BASE TEFLON

DLC HOOK BASE DLC COATING
MINIMAL OIL

Ti HOOK BASE
TITANIUM COATING

ADJ ADJUSTABLE STRONG
NEEDLE GUARD

N WITH NON SLIP SPRING

* = EXCLUSIVE ITEMS

KERDER (客德)

MACHINE (機器)	HOOK (旋梭)					BOBBIN CASE & CAP (梭壳 & 梭帽)		
	PART NO. (配件型号)	KOBAN NO.1 (佐文型号1)	PAGE	KOBAN NO.2 (佐文型号2)	PAGE	PART NO. (配件型号)	KOBAN NO. (佐文型号)	PAGE
KD-20U		KR24U-42	9				SC35	24
KD-810/-820		KRT31-R	15					
KD-8100-3		KHS12-S	2				SC31	24
KD-8100-5/-7		KHS12-R	1				SC31	24

KING'S (王品)

MACHINE (機器)	HOOK (旋梭)					BOBBIN CASE & CAP (梭壳 & 梭帽)		
	PART NO. (配件型号)	KOBAN NO.1 (佐文型号1)	PAGE	KOBAN NO.2 (佐文型号2)	PAGE	PART NO. (配件型号)	KOBAN NO. (佐文型号)	PAGE
HC-335		KR24-B	8				SC35	24
HC-471/-474/-491		SKRT470-R with Cap	16	KRT470-R hook only	16		SCPF15	23
HC-616/-618		SKRT545 with Cap		KRT545 hook only			SCP545	23
HC-810/-815/-820		KRT31-R	15					
HC-825/-919/-929		KRT31-R	15					
HC-832		KRT12-5M	11					
HC-835		KRT12-5LM	13					

KINGTEX (精機)

MACHINE (機器)	HOOK (旋梭)					BOBBIN CASE & CAP (梭壳 & 梭帽)		
	PART NO. (配件型号)	KOBAN NO.1 (佐文型号1)	PAGE	KOBAN NO.2 (佐文型号2)	PAGE	PART NO. (配件型号)	KOBAN NO. (佐文型号)	PAGE
KL-300H/-300M/ -310M/-500M	600-03040	KHS12-S	2			600-03041	SC31	24
KL-300M-A	HK111-0002B	KHS12-SPD2	3			HK111-0001B	SC31-NS N	24

MAQI (美机)

MACHINE (機器)	HOOK (旋梭)					BOBBIN CASE & CAP (梭壳 & 梭帽)		
	PART NO. (配件型号)	KOBAN NO.1 (佐文型号1)	PAGE	KOBAN NO.2 (佐文型号2)	PAGE	PART NO. (配件型号)	KOBAN NO. (佐文型号)	PAGE
LS1310-E-35		SH181H	21				SC181H N	28
LS1900H420		SH282	21				SC980-2 N	29
LS2052100701		KRT12-5B	11					
LS2052H100701		KRT12-5LM	13					
LS2252100701/ 225210070102		SKRT12-5MK with Cap	11	KRT12-5MK hook only	11		SCP-MK	23
LS2252H100701/ 2252H10070102		SKRT12-5LMK with Cap	14	KRT12-5LMK hook only	14		SCP-LMK	23
LS68425H2301		KRT12-5BH						
LS68725H2301		KRT872L	13					
LS7810301		KRP41-LH2	10				SC70-771NS N	27
LS-T1790B/ -T1790S-0429		KRP41-LH3ICC DLC	10				SC70-LH3NS N	27
PF22841114		KRP457JTI Ti	10	KRP457JICC DLC	10		SC70-3JNS N	27
PF8450M-D30849		SKRT845KC with Cap	12	KRT842KC hook only	12		SCP-842BKC	23
PF8750D30849		SKRT875LKC with Cap	14	KRT875LC hook only	14		SCP-LBKC	23
PFM90533		KHS20-SMP	5				SC33-LNS N	26

Teflon 特氟隆内釜

DLC 像鑽石一樣堅硬的石炭塗層内釜

Ti 鈦塗層

ADJ 护针片調整旋梭

N 附防止空轉彈簧片

* = EXCLUSIVE ITEMS

MELCO

MACHINE (机器)	HOOK (旋梭)					BOBBIN CASE & CAP (梭壳 & 梭帽)		
	PART NO. (配件型号)	KOBAN NO.1 (佐文型号1)	PAGE	KOBAN NO.2 (佐文型号2)	PAGE	PART NO. (配件型号)	KOBAN NO. (佐文型号)	PAGE
EMC1, EMC10/12, EMT10/4T, EMT10T		KHS12-RYPICC DLC	2	KHS12-RYP	1		SC35-NS N	24
							SC34-2NS N	24

MILLION SPECIAL (萬特)

MACHINE (机器)	HOOK (旋梭)					BOBBIN CASE & CAP (梭壳 & 梭帽)		
	PART NO. (配件型号)	KOBAN NO.1 (佐文型号1)	PAGE	KOBAN NO.2 (佐文型号2)	PAGE	PART NO. (配件型号)	KOBAN NO. (佐文型号)	PAGE
MS-1245		SKRT1242-R with Cap	19	KRT1242-R hook only	19		SCP545	23
MS-1341		SKRT341G with Cap	20	KRT341G hook only	20		SCP545	23
MS-20U		KR24U-42	9				SC35	24
MS-20U143		KR24U-42	9				SC35	24
MS-335/-335N		KR24-B	8				SC35	24
MS-370L		KHS20-R	4				SC33-L	26
MS-652/-B652		KR24-B	8				SC35	24
MS-3811L		KHS20-R	4				SC33-L	26
MS-474-500		SKRT470-R with Cap	16	KRT470-R hook only	16		SCPF15	23
MS-491-800		SKRT470-R with Cap	16	KRT470-R hook only	16		SCPF15	23
MS-674D-500		SKRT470-R with Cap	16	KRT470-R hook only	16		SCPF15	23
MS-691D-800		SKRT470-R with Cap	16	KRT470-R hook only	16		SCPF15	23
MS-474-510/-530/ -530P		SKRT470C-R with Cap	16	KRT470C-R hook only	16		SCPF441	23
MS-491-810/-830/ -830P/-860P		SKRT470C-R with Cap	16	KRT470C-R hook only	16		SCPF441	23
MS-674D-510/-530/ -530P		SKRT470C-R with Cap	16	KRT470C-R hook only	16		SCPF441	23
MS-691D-810/-830/ -830P		SKRT470C-R with Cap	16	KRT470C-R hook only	16		SCPF441	23
MS-674DL-510		SKRT470LC-R with Cap		KRT470LC-R hook only			SCP545C	
MS-691DL-810		SKRT470LC-R with Cap		KRT470LC-R hook only			SCP545C	
MS-735/-B735R		KHS12-S	2	KHS12-R For Heavy Materials	1		SC31	24
MS-810/-820		KRT31-NR	15					
MS-810-H		KRT31-RGH						
MS-B842		KRT12-5M	11					
MS-B842-3/-5		KRT12-5M	11					
MS-B842-403/-405		KRT12-5BFCI						
MS-B842-5		KRT12-5LM	13					
MS-B845		SKRT12-5MK with Cap	11	KRT12-5MK hook only	11		SCP-MK	23
MS-B845-3/-5		SKRT12-5MK with Cap	11	KRT12-5MK hook only	11		SCP-MK	23
MS-B872-3/-5		KRT12-5LM	13					
MS-B872-403/-405		SKRT872LC with Cap	14	KRT875LC hook only	14		SCP-LBC	23

Teflon HOOK BASE TEFLON

DLC HOOK BASE DLC COATING
MINIMAL OIL

Ti HOOK BASE
TITANIUM COATING

ADJ ADJUSTABLE STRONG
NEEDLE GUARD

N WITH NON SLIP SPRING

* = EXCLUSIVE ITEMS

MILLION SPECIAL (萬特)								
MACHINE (機器)	HOOK (旋梭)					BOBBIN CASE & CAP (梭壳 & 梭帽)		
	PART NO. (配件型号)	KOBAN NO.1 (佐文型号1)	PAGE	KOBAN NO.2 (佐文型号2)	PAGE	PART NO. (配件型号)	KOBAN NO. (佐文型号)	PAGE
MS-B875		KRT12-5LM	13					
MS-B875/-B875-5		SKRT12-5LMK with Cap	14	KRT12-5LMK hook only	14		SCP-LMK	23
MS-B875-3/-403/-405		SKRT875LKC with Cap	14	KRT875LC hook only	14		SCP-LBKC	23

MITSUBISHI (三菱)								
MACHINE (機器)	HOOK (旋梭)					BOBBIN CASE & CAP (梭壳 & 梭帽)		
	PART NO. (配件型号)	KOBAN NO.1 (佐文型号1)	PAGE	KOBAN NO.2 (佐文型号2)	PAGE	PART NO. (配件型号)	KOBAN NO. (佐文型号)	PAGE
CS-4150BT	MP43A0120/MP61A6120	KRT12-5LMKC-CI	13					
CU-865-12	MF65B0120	KR21-R	8			MF10E0125	SC31	24
CU-865-22FP	MF25B0120	KHS20-RM2	4			MF25E0125	SC33-L	26
DB-126-10	MF16A0120	KHS12-S	2			MF10E0125	SC31	24
DB-130-7/-13	MF42A0120	KHS12-R	1			MF10E0125	SC31	24
DB-130-10/-11/-14	MF16A0120	KHS12-S	2			MF10E0125	SC31	24
DB-170-10/-171	MF16A0120	KHS12-S	2			MF10E0125	SC31	24
DB-130-22	MF25B0120	KHS20-RM2	4			MF25E0125	SC33-L	26
DB-130G-22	MF25B0120	KHS20-RM2	4			MF25E0125	SC33-L	26
DB-130-12/-130G-12/ -130GM-127	MF42A0120	KHS12-R	1			MF10E0125	SC31	24
DB-189-10	MF40A0120	KHS12-SPD2	3			MF40E0125	SC31-NS N	24
DB-189-22BZ	MF45A0120	KHS20-GTMP	4			MG44E0125	SC33-LNS N	26
DB-286	MN70E0120	KRT12-5M	11					
DB-320-10	MF60A0120	KR21-S	8			MF10E0125	SC31	24
DB-320-12/-325	MF65B0120	KR21-R	8			MF10E0125	SC31	24
DB-325-22/-327	MF25B0120	KHS20-RM2	4			MF25E0125	SC33-L	26
DN-105-22	MP00A0120	KRT12-5LMC	13					
DN-107	MP00A0120	KRT12-5LMC	13					
DN-120-22	MP00A0120	KRT12-5LMC	13					
DN-122/-127	MP00A0120	KRT12-5LMC	13					
DN-125-22	MP00A0120	KRT12-5LMC	13					
DN-260/-7	MN70E0120	KRT12-5M	11					
DN-260-22/-262/ -265-22/-267	MN69E0120	KRT12-5LM	13					
DN-265	MN70E0120	KRT12-5M	11					
DN-275-10	MN25A0120	SKRT12-5MK with Cap	11	KRT12-5MK hook only	11	MN27A0125	SCP-MK	23
DN-275A-10	MN25A0120	SKRT12-5MK with Cap	11	KRT12-5MK hook only	11	MN27A0125	SCP-MK	23
DN-275A-20/D275-20	MN26B0120	SKRT12-5LMK with Cap	14	KRT12-5LMK hook only	14	MN28B0125	SCP-LMK	23
DN-350-12	MF16A0120	KHS12-S	2			MF10E0125	SC31	24
DN-350-12/-352	MN30A0120	KR21-RD	8			MF10E0125	SC31	24
DU-100-22/DU-102	MP00A0120	KRT12-5LMC	13					
DU-123/-128	MP03B0120	KRT14-5M						
DX-370	MF60A0120	KR21-S	8			MF10E0125	SC31	24
DX-370-20/-377	MF25B0120	KHS20-RM2	4			MF25E0125	SC33-L	26
DX-870	MQ70A0120	KRT190	15					
DY-253/-253-00	MG23E0120	KRT132	17					
DY-330-12	MF42A0120	KHS12-R	1			MF10E0125	SC31	24

Teflon 特氟隆内釜

DLC 像鑽石一樣堅硬的石炭塗層内釜

Ti 鈦塗層

ADJ 护针片調整旋梭

N 附防止空轉彈簧片

* = EXCLUSIVE ITEMS

MITSUBISHI (三菱)

MACHINE (机器)	HOOK (旋梭)					BOBBIN CASE & CAP (梭壳 & 梭帽)		
	PART NO. (配件型号)	KOBAN NO.1 (佐文型号1)	PAGE	KOBAN NO.2 (佐文型号2)	PAGE	PART NO. (配件型号)	KOBAN NO. (佐文型号)	PAGE
DY-330-22/-337/-340-22/ -350-22/-370-22	MF25B0120	KHS20-RM2	4			MF25E0125	SC33-L	26
DY-339-22	MG40B0120	KHS20-RPM2	5			MG40E0125	SC33-LNS N	26
DY-340-12	MF42A0120	KHS12-R	1			MF10E0125	SC31	24
DY-340-22	MG44B0120	KHS20-RMP	4			MG44E0125	SC33-LNS N	26
DY-349-22BZ	MG44B0120	KHS20-RMP	4			MG44E0125	SC33-LNS N	26
DY-350-12	MF42A0120	KHS12-R	1			MF10E0125	SC31	24
DY-359-22/-22BZ	MG44B0120	KHS20-RMP	4			MG44E0125	SC33-LNS N	26
DY-370-12	MF42A0120	KHS12-R	1			MF10E0125	SC31	24
LS2-130-BOB	MF25B0120	KHS20-RM2	4			MF25E0125	SC33-L	26
LS2-130-H/-HOB	MF42A0120	KHS12-R	1			MF10E0125	SC31	24
LS2-150-MOB	MF16A0120	KHS12-S	2			MF10E0125	SC31	24
LS2-190/-HIT/-HITZ/-HITZ/ -HITZ4/-HITZ6/-MIT	MF42B0120	KHS12-GTHPD	1			MF40E0125	SC31-NS N	24
LS2-190-MITZ	MF40A0120	KHS12-SPD2	3			MF40E0125	SC31-NS N	24
LS2-1130-B/-BOB/-HOB	MF25B0120	KHS20-RM2	4			MF25E0125	SC33-L	26
LS2-1130-H/-HOB	MF42A0120	KHS12-R	1			MF10E0125	SC31	24
LS2-1130-MOB	MF16A0120	KHS12-S	2			MF10E0125	SC31	24
LS2-1180-H	MF42B0120	KHS12-GTHPD	1			MF40E0125	SC31-NS N	24
LS2-1180-L1T/-M1T/-M1TW	MF40A0120	KHS12-SPD2	3			MF40E0125	SC31-NS N	24
LS2-1280-B1T	MF25B0120	KHS20-RM2	4			MF25E0125	SC33-L	26
LS2-1280-H1TW	MF42A0120	KHS12-R	1			MF10E0125	SC31	24
LS2-1280-M/-M1T	MF40A0120	KHS12-SPD2	3			MF40E0125	SC31-NS N	24
LS2-1380-M1T/-M1TW	MF40A0120	KHS12-SPD2	3			MF40E0125	SC31-NS N	24
LS2-1780-B1T/-180/-180-BIT	MF45A0120	KHS20-GTMP	4			MG44E0125	SC33-LNS N	26
LS2-1780-M1TW	MF40A0120	KHS12-SPD2	3			MF40E0125	SC31-NS N	24
LS2-2210-M/ -2210-M1T/-M1TW	MF40A0120	KHS12-SPD2	3			MN35A0125	SC82-JNS N	25
LS2-3300-BOB	MF25B0120	KHS20-RM2	4			MF25E0125	SC33-L	26
LS2-3310-B1T	MG44B0120	KHS20-RMP	4			MG44E0125	SC33-LNS N	26
LG2-3370-M/-M1T	MF40A0120	KHS12-SPD2	3			MF40E0125	SC31-NS N	24
LT2-220-BOB	MN12B0120	KRT12-5LMR						
LT2-220-BOB	MN69E0120	KRT12-5LM	13					
LT2-220-BOB	MN26B0120	SKRT12-5LMK with Cap	14	KRT12-5LMK hook only	14	MN28B0125	SCP-LMK	23
LT2-220-MOB	MN70E0120	KRT12-5M	11					
LT2-230-B1T	MN52E0120	SKRT12-5LMKC-C with Cap		KRT12-5LMKC-C hook only		MN52E0125/ MN62A0125	SCP-LMC	
LT2-230-M/-M1TW	MN50E0120	SKRT12-5MC-2 with Cap		KRT12-5MC hook only		MN50E0125	SCP-MKC	
LT2-230-MITW	MQ60A0120	SKRT12-5MC-1 with Cap		KRT12-5MC hook only		MA60A0125	SCP-MC	
LT2-240-MOB	MN25A0120	SKRT12-5MK with Cap	11	KRT12-5MK hook only	11	MN27A0125	SCP-MK	23
LT2-250-B1T	MN62E0120	SKRT12-5LMKC-1 with Cap		KRT12-5LMKC hook only		MN62A0125	SCP-LMKC	
LT2-2220-BOB	MN69E0120	KRT12-5LM	13					
LT2-2220-MOB	MN70E0120	KRT12-5M	11					
LT2-2230-B1T	MN74E0120	KRT12-5LMKCI	13					
LT2-2230-M/-2230-M1TW	MN72E0120	KRT12-5MCI						
LT2-2240-BOB	MN26B0120	SKRT12-5LMK with Cap	14	KRT12-5LMK hook only	14	MN28B0125	SCP-LMK	23

Teflon HOOK BASE TEFLON

DLC HOOK BASE DLC COATING
MINIMAL OIL

Ti HOOK BASE
TITANIUM COATING

ADJ ADJUSTABLE STRONG
NEEDLE GUARD

N WITH NON SLIP SPRING

* = EXCLUSIVE ITEMS

MITSUBISHI (三菱)								
MACHINE (機器)	HOOK (旋梭)					BOBBIN CASE & CAP (梭壳 & 梭帽)		
	PART NO. (配件型号)	KOBAN NO.1 (佐文型号1)	PAGE	KOBAN NO.2 (佐文型号2)	PAGE	PART NO. (配件型号)	KOBAN NO. (佐文型号)	PAGE
LT2-2240-MOB	MN25A0120	SKRT12-5MK with Cap	11	KRT12-5MK hook only	11	MN27A0125	SCP-MK	23
LT2-2250-B1T	MN62E0120	SKRT12-5LMKC-1 with Cap		KRT12-5LMKC hook only		MN62A0125	SCP-LMKC	
LT2-2250-M1TW	MQ60A0120	SKRT12-5MC-1 with Cap		KRT12-5MC hook only		MA60A0125	SCP-MC	
LU2-400-BOB	MP00A0120	KRT12-5LMC	13					
LU2-410-B1T/-430	MP43A0120/ MP61A6120	KRT12-5LMKC-CI	13					
LU2-410-BIT/-430-B1T	MN52E0120/ MP41A0120	SKRT12-5LMKC-C with Cap		KRT12-5LMKC-C hook only		MN52E0125/ MN62A0125	SCP-LMC	
LU2-420-BOB	MP00A0120	KRT12-5LMC	13					
LU2-4400	MP00A0120	KRT12-5LMC	13					
LU2-4400-BOB	MP00A0120	KRT12-5LMC	13					
LU2-4410-B	MP43A0120/ MP61A6120	KRT12-5LMKC-CI	13					
LU2-4410-B1T	MN52E0120/ MP41A0120	SKRT12-5LMKC-C with Cap		KRT12-5LMKC-C hook only		MN52E0125/ MN62A0125	SCP-LMC	
LU2-4410-B1T-BFCS/ -CS	MP43A0120/ MP61A6120	KRT12-5LMKC-CI	13					
LU2-4412-B1T/ -4412-B1T-CS	MP43A0120/ MP61A6120	KRT12-5LMKC-CI	13					
LU2-4420	MP00A0120	KRT12-5LMC	13					
LU2-4420-BOB	MP00A0120	KRT12-5LMC	13					
LU2-4430-B1T	MP43A0120/ MP61A6120	KRT12-5LMKC-CI	13					
LU2-4650-B1T	MP43A0120/ MP61A6120	KRT12-5LMKC-CI	13					
LU2-4652-B1T	MP43A0120/ MP61A6120	KRT12-5LMKC-CI	13					
LU2-4710-B1T	MP43A0120/ MP61A6120	KRT12-5LMKC-CI	13					
LU2-4730-B1T	MP43A0120/ MP61A6120	KRT12-5LMKC-CI	13					
LU3-6860	MP68M8120	SKRT341-NR with Cap	20	KRT341-NR hook only	20		SCP-545	23
LU5-5720-B0T	MP57A0120	KRT8-LPBV-R ADJ						
LX2-371-MO	MF60A0120	KR21-S	8			MF10E0125	SC31	24
LX5-871-MO	MQ70A0120	SKRT190G with Cap	15	KRT190G hook only	15		SCPF19	
LX2-630-M1	MQ60A0120	SKRT12-5MC-1 with Cap		KRT12-5MC hook only		MA60A0125	SCP-MC	
LY2-3300-BOB	MF25B0120	KHS20-RM2	4			MF25E0125	SC33-L	26
LY2-3750	MG44B0120	KHS20-RMP	4			MG44E0125	SC33-LNS N	26
LY3-6840-BOT	MG44B0120	KHS20-RMP	4			MG44E0125	SC33-LNS N	26
LY3-6850-B1T	MG44B0120	KHS20-RMP	4			MG44E0125	SC33-LNS N	26
LZ-720/-780/-790	MT70A0120	KRP457	10			MT70E0125	SC70-3	27
PB-810/-810-10/-820/-830	VM01A0120	KRT136M						
PLK-1210/-1410/-1710	MG44B0120	KHS20-RMP	4			MG44E0125	SC33-LNS N	26

Teflon 特氟隆内釜

DLC 像鑽石一樣堅硬的石炭塗層内釜

Ti 鈦塗層

ADJ 护针片調整旋梭

N 附防止空轉彈簧片

* = EXCLUSIVE ITEMS

MITSUBISHI (三菱)

MACHINE (机器)	HOOK (旋梭)					BOBBIN CASE & CAP (梭壳 & 梭帽)		
	PART NO. (配件型号)	KOBAN NO.1 (佐文型号1)	PAGE	KOBAN NO.2 (佐文型号2)	PAGE	PART NO. (配件型号)	KOBAN NO. (佐文型号)	PAGE
PLK-7191/-7194/-7203	MN52E0120/ MP41A0120	SKRT12-5LMKC-C with Cap		KRT12-5LMKC-C hook only		MN52E0125/ MN62A0125	SCP-LMC	
PLK-03BTA/-0504/-0604/ -E03BTA	MS01A1120	SH430-H	21			MS01A0125	SC430 N	29
PLK-03BTA/-0804/ -E03BT/-E0504	MS01A0120	SH430	21			MS01A0125	SC430 N	29
PLK-A0804/-A1710/ -A2016/-A3530	MA10A0120	SH181	21			MS17A0125	SC181 N	28
PLK-A2016	MS17A1120	SH181H	21			MS17A0125	SC181 N	28
PLK-A3530	MS17A1120	SH181H	21			MS17A0125	SC181 N	28
PLK-A4516	MS17A1120	SH181H	21			MS17A0125	SC181 N	28
PLK-G1010	MS17A1120	SH181H	21			MS17A0125	SC181 N	28
PLK-G4030	MS17A1120	SH181H	21			MS17A0125	SC181 N	28
PLK-E1008H/-E2008H	MB18A0120	KSP204N	18					
PLK-E1010/-E1010	MA10A0120	SH181	21			MS17A0125	SC181 N	28
PLK-E2516/-E4030	MA10A0120	SH181	21			MS17A0125	SC181 N	28
PLK-E4519/-E5050	MA10A0120	SH181	21			MS17A0125	SC181 N	28
PLK-E6019/-E6030	MA10A0120	SH181	21			MS17A0125	SC181 N	28
PLK-E10050	MA10A0120	SH181	21			MS17A0125	SC181 N	28
PLK-E2010R/ -E2516A/-E2516R	MG44B0120	KHS20-RMP	4			MG44E0125	SC33-LNS N	26
PLK-G10050R/-G2010R	MG44B0120	KHS20-RMP	4			MG44E0125	SC33-LNS N	26
PLK-G1010/-G1010-EX/ -G1010-K2	MA10A0120	SH181	21			MS17A0125	SC181 N	28
PLK-G1306/-G2516/ -G10050	MA10A0120	SH181	21			MS17A0125	SC181 N	28
PLK-G2516-YU/ -G4030/-G6030	MA10A0120	SH181	21			MS17A0125	SC181 N	28
PLK-G4030R/-G5050/ -G5050R/-G6030R/-J6040R	MG44B0120	KHS20-RMP	4			MG44E0125	SC33-LNS N	26
PLK-G6030WR/-E7191/ -E7194/-E7203	ML70E0120/ MN62E0120	SKRT12-5LMKC-2 with Cap		KRT12-5LMKC hook only		MN52E0125/ MN62A0125	SCP-LMC	
PLY-501F	MN26B0120	SKRT12-5LMK with Cap	14	KRT12-5LMK hook only	14	MN28B0125	SCP-LMK	23
PLY-1185/-7181/-7182	ML70E0120/ MN62E0120	SKRT12-5LMKC-2 with Cap		KRT12-5LMKC hook only		MN52E0125/ MN62A0125	SCP-LMC	
PLY-7191/-7194/-7202	ML70E0120/ MN62E0120	SKRT12-5LMKC-2 with Cap		KRT12-5LMKC hook only		MN52E0125/ MN62A0125	SCP-LMC	
PLY-7203/-7206E	ML70E0120/ MN62E0120	SKRT12-5LMKC-2 with Cap		KRT12-5LMKC hook only		MN52E0125/ MN62A0125	SCP-LMC	
PLY-7206	MN52E0120/ MP41A0120	SKRT12-5LMKC-C with Cap		KRT12-5LMKC-C hook only		MN52E0125/ MN62A0125	SCP-LMC	

NECCHI (尼奇)

MACHINE (机器)	HOOK (旋梭)					BOBBIN CASE & CAP (梭壳 & 梭帽)		
	PART NO. (配件型号)	KOBAN NO.1 (佐文型号1)	PAGE	KOBAN NO.2 (佐文型号2)	PAGE	PART NO. (配件型号)	KOBAN NO. (佐文型号)	PAGE
533/535/720/721/840		KR24	8				SC35	24
800/801/803/810/813	522514	KR21-S	8				SC31	24
RM/RVG/RVM/UAN-1501	522514	KR21-S	8				SC31	24

Teflon HOOK BASE TEFLON

DLC HOOK BASE DLC COATING
MINIMAL OIL

Ti HOOK BASE
TITANIUM COATING

ADJ ADJUSTABLE STRONG
NEEDLE GUARD

N WITH NON SLIP SPRING

* = EXCLUSIVE ITEMS

New-tech								
MACHINE (機器)	HOOK (旋梭)					BOBBIN CASE & CAP (梭壳 & 梭帽)		
	PART NO. (配件型号)	KOBAN NO.1 (佐文型号1)	PAGE	KOBAN NO.2 (佐文型号2)	PAGE	PART NO. (配件型号)	KOBAN NO. (佐文型号)	PAGE
2025/1/3, 2050/ 5, 2250/5, 2150/5		SKRT842CZAICC with Cap DLC		KRT842KCICC hook only DLC			SCP-842BCZA	
2400/1, 2600/1/9/ 10, 2700/1/9/10		KHS12-SPD2	3				SC31-NS N	24
3100/2, 3300/1, 3500/1/2		KHS12-SPD2	3				SC31-NS N	24
3000/4/5/6		KHS20-RP3E2KSICC DLC		KHS20-RP3E2KS			SC33-LHONS N	

NITAKA (日高)								
MACHINE (機器)	HOOK (旋梭)					BOBBIN CASE & CAP (梭壳 & 梭帽)		
	PART NO. (配件型号)	KOBAN NO.1 (佐文型号1)	PAGE	KOBAN NO.2 (佐文型号2)	PAGE	PART NO. (配件型号)	KOBAN NO. (佐文型号)	PAGE
DY-350/-350L/-370L		KHS20-R	4				SC33-L	26
DY-3300/-3810/ -3811-L/-3812-L		KHS20-R	4				SC33-L	26
TC-1341		SKRT341-NR with Cap	20	KRT341-NR hook only	20		SCP545	23
TC-1508/-2508		KRT-LS2R	13					
TC-1530/-2530/ -3370/-3810		KHS20-R	4				SC33-L	26
TC-8BL/-28BL/-28L/-88BL/ -88L/-288BL/-288L		KRT8-LC-RB-CS						
TC-341		SKRT341G with Cap	20	KRT341G hook only	20		SCP545	23
TC-341L		KRT341-NHI						
TC-360-5/-6/-7/-8/-9/ -10/-12/-13/-14/-15		SKRT341G with Cap	20	KRT341G hook only	20		SCP545	23
TC-360L		SKRT341G with Cap	20	KRT341G hook only	20		SCP545	23
TC-8/-8B/-28/-28B/ -88/-88B/-288/-288B		KRT-LS2R	13					
TC-8370/-8371/ -8372/-8872		SKRT341G with Cap	20	KRT341G hook only	20		SCP545	23
TC-8370L/-8371L/ -8372L/-8872L		KRT341-NHI						
TC-9510/-9511/ -9520		SKRT341G with Cap	20	KRT341G hook only	20		SCP545	23
TC-9510L/-9511L/-9520L		KRT341-NHI						
TC-360-1/-2/-3/-4		SKRT391 with Cap		KRT391 hook only			SCPF15H	23
TC-360-11		SKRT151MO with Cap		KRT151MO hook only			SCP151MO	
TC-810/-810S/-820/-820S		KRT31-NR	15					
TC-841-22/-847-5/ -872/-877-4		KRT12-5LM	13					
TC-881/-882		SKRT470-R with Cap	16	KRT470-R hook only	16		SCPF15	23
TC-8360/-8361/ -8367		SKRT391 with Cap		KRT391 hook only			SCPF15H	23
TC-8410/-8411/-8420/ -8422/-8450		KRT31-NR	15					

Teflon 特氟隆内釜

DLC 像鑽石一樣堅硬的石炭塗層内釜

Ti 鈦塗層

ADJ 护针片調整旋梭

N 附防止空轉彈簧片

* = EXCLUSIVE ITEMS

NITAKA (日高)

MACHINE (机器)	HOOK (旋梭)					BOBBIN CASE & CAP (梭壳 & 梭帽)		
	PART NO. (配件型号)	KOBAN NO.1 (佐文型号1)	PAGE	KOBAN NO.2 (佐文型号2)	PAGE	PART NO. (配件型号)	KOBAN NO. (佐文型号)	PAGE
TC-8855/-8856/ -8865/-8866		SKRT391 with Cap		KRT391 hook only			SCPF15H	23
TC-9255/-9256/ -9365/-9366		SKRT391 with Cap		KRT391 hook only			SCPF15H	23
TC-9410/-9411/-9420		KRT31-NR	15					
TC-B842-403/-405		KRT12-5BFCI						
TC2-B845		SKRT12-5MK3 with Cap		KRT12-5MK hook only			SCP-MK3	
TC-B845-403/-405		SKRT845KC with Cap	12	KRT842KC hook only	12		SCP-842BKC	23
TC-B872-403/-405		KRT12-5LMKCI	13					
TC-B875-403/-405		SKRT875LKC with Cap	14	KRT875LC hook only	14		SCP-LBKC	23
TC2-B1883		SKRT12-5MK3 with Cap		KRT12-5MK hook only			SCP-MK3	
TC2-B1885		SKRT12-5LMK with Cap	14	KRT12-5LMK hook only	14		SCP-LMK	23
TC2-B842		KRT12-5M	11					
TC2-B842-40		KRT12-5BFCI						
TC2-B845-40		KRT12-5BFCI					SCP-842BC	23
TC2-B847-5/-B872/ -B935		KRT12-5LM	13					
TC2-B872-40		KRT12-5LMKCI	13					
TC2-B875		SKRT12-5LMK2 with Cap		KRT12-5LMK hook only			SCP-LMKC2	
TDY-3811L/-3812L		KHS20-R	4				SC33-L	26
TTC-1550		KHS12-2S	1				SC31	24
TTC-3750		KHS20-R	4				SC33-L	26
TTC-3750L		KHS20-HPEW	4				SC33-LD N	26
TTC-15506		KHS12-R	1				SC31	24
TCC-B841/-B847-3/ -B877-3		KRT12-5M	11					
TCC-B8423		KRT12-5M	11					
YU-380/-380L		KHS20-HPEW	4				SC33-LD N	26

PANDA (建聯)

MACHINE (机器)	HOOK (旋梭)					BOBBIN CASE & CAP (梭壳 & 梭帽)		
	PART NO. (配件型号)	KOBAN NO.1 (佐文型号1)	PAGE	KOBAN NO.2 (佐文型号2)	PAGE	PART NO. (配件型号)	KOBAN NO. (佐文型号)	PAGE
JL-20U		KR24U-42	9				SC35	24
JL-457A		KRP457-W	10				SC70-3	27
JL-781		KRP41-LH2	10				SC70-771	27

PEGASUS (飛馬)

MACHINE (机器)	HOOK (旋梭)					BOBBIN CASE & CAP (梭壳 & 梭帽)		
	PART NO. (配件型号)	KOBAN NO.1 (佐文型号1)	PAGE	KOBAN NO.2 (佐文型号2)	PAGE	PART NO. (配件型号)	KOBAN NO. (佐文型号)	PAGE
DPS-2/-3/-4	179077000009	KRP41-S	10			178081000009	SC70-2	27

Teflon HOOK BASE TEFLON

DLC HOOK BASE DLC COATING
MINIMAL OIL

Ti HOOK BASE
TITANIUM COATING

ADJ ADJUSTABLE STRONG
NEEDLE GUARD

N WITH NON SLIP SPRING

* = EXCLUSIVE ITEMS

PEMAL (良機)								
MACHINE (機器)	HOOK (旋梭)					BOBBIN CASE & CAP (梭壳 & 梭帽)		
	PART NO. (配件型号)	KOBAN NO.1 (佐文型号1)	PAGE	KOBAN NO.2 (佐文型号2)	PAGE	PART NO. (配件型号)	KOBAN NO. (佐文型号)	PAGE
CDL-1388N		KHS12-R	1				SC31	24
CDL-5550N		KHS12-S	2				SC31	24
LT2-B842-03		KRT12-5M	11					
LT2-B872		KRT12-5M	11					
LT2-B845-3		KRT12-5LM	13					
LT2-B875		KRT12-5LM	13					
PM-780		KRP41-LH	10				SC70-2	27
PM-1828/-1836/-1850		SH280	21				SC980N	29

PFAFF (百福)								
MACHINE (機器)	HOOK (旋梭)					BOBBIN CASE & CAP (梭壳 & 梭帽)		
	PART NO. (配件型号)	KOBAN NO.1 (佐文型号1)	PAGE	KOBAN NO.2 (佐文型号2)	PAGE	PART NO. (配件型号)	KOBAN NO. (佐文型号)	PAGE
114/115/116	91-008250-91 W/O BC	KRP3114				91-008243-91	SC70-31	
120/122	91-010165-91 W/CAP	SKRT151S with Cap		KRT151S hook only		91-010159-91	SCPF15	23
130		KR238-14	8				SC39-14	24
130	91-064662-91 W/O BC	KR238	8			91-009076-91	SC39	24
133/134	91-009264-91 W/O BC	KR134	8			91-009076-91	SC39	24
138		KR238-14	8				SC39-14	24
138	91-064662-91 W/O BC	KR238	8			91-009076-91	SC39	24
141~146	91-010165-91 W/CAP	SKRT151S with Cap		KRT151S hook only		91-010159-91	SCPF15	23
141~146	91-010850-91 W/CAP	SKRT145 with Cap		KRT145 hook only		91-010159-91	SCPF15	23
141~146	91-010896-91 W/CAP	SKRT191 with Cap		KRT191 hook only		91-010159-91	SCPF15	23
142-720/-721	91-010165-91 W/CAP	SKRT151S with Cap		KRT151S hook only		91-010159-91	SCPF15	23
151/155	91-010165-91 W/CAP	SKRT151S with Cap		KRT151S hook only		91-010159-91	SCPF15	23
175-196	91-010850-91 W/CAP	SKRT145 with Cap		KRT145 hook only		91-010159-91	SCPF15	23
175-196	91-010896-91 W/CAP	SKRT191 with Cap		KRT191 hook only		91-010159-91	SCPF15	23
190	91-015023-91 W/CAP	SKRT190G with Cap	15	KRT190G hook only	15		SCPF19	
191~196,194-720	91-010165-91 W/CAP	SKRT151S with Cap		KRT151S hook only		91-010159-91	SCPF15	23
230	91-064662-91 W/O BC	KR238	8			91-009076-91	SC39	24
234	91-063090-91 W/O BC	KR234				91-009076-91	SC39	24
238	91-064662-91 W/O BC	KR238	8			91-009076-91	SC39	24
240A/B	91-010165-91 W/CAP	SKRT151S with Cap		KRT151S hook only		91-010159-91	SCPF15	23
260	91-064662-91 W/O BC	KR238	8			91-009076-91	SC39	24
290A/B	91-010165-91 W/CAP	SKRT151S with Cap		KRT151S hook only		91-010159-91	SCPF15	23
335G	91-060581-91 W/BC	KR335-V	9			91-174955-91	SC335-V N	28
341-347	91-014192-91 W/CAP	SKRT345 with Cap		KRT345 hook only		91-010159-91	SCPF15	23
353-354	91-014192-91 W/CAP	SKRT345 with Cap		KRT345 hook only		91-010159-91	SCPF15	23

Teflon 特氟隆内釜

DLC 像鑽石一樣堅硬的石炭塗層内釜

Ti 鈦塗層

ADJ 护针片調整旋梭

N 附防止空軋彈簧片

* = EXCLUSIVE ITEMS

PFAFF (百福)

MACHINE (机器)	HOOK (旋梭)					BOBBIN CASE & CAP (梭壳 & 梭帽)		
	PART NO. (配件型号)	KOBAN NO.1 (佐文型号1)	PAGE	KOBAN NO.2 (佐文型号2)	PAGE	PART NO. (配件型号)	KOBAN NO. (佐文型号)	PAGE
390		SKRT390 with Cap		KRT390 hook only			SCPF19	
434	91-061136-91 W/O BC	KHS46				91-009076-91	SC39	24
437~439	91-168883-91 W/O BC	KHS438	7			91-009076-91	SC39	24
441~448	91-118876-91 W/CAP	SKRT470-O-S with Cap		KRT470-O-S hook only		91-010159-91	SCPF15	23
451~457	91-118876-91 W/CAP	SKRT470-O-S with Cap		KRT470-O-S hook only		91-010159-91	SCPF15	23
461~469	91-171820-91 W/O BC	KHS480	7			91-009076-91	SC39	24
461-900~469-900	91-171820-91 W/O BC	KHS480	7			91-009076-91	SC39	24
470	91-119386-91 W/CAP	SKRT470-S with Cap		KRT470-S hook only		91-010159-91	SCPF15	23
471~493	91-119386-91 W/CAP	SKRT470-S with Cap		KRT470-S hook only		91-010159-91	SCPF15	23
471~493	91-119767-91 W/CAP	SKRT470-R with Cap	16	KRT470-R hook only	16	91-010159-91	SCPF15	23
481-900~489-900	91-171820-91 W/O BC	KHS480	7			91-009076-91	SC39	24
490	91-119386-91 W/CAP	SKRT470-S with Cap		KRT470-S hook only		91-010159-91	SCPF15	23
490	91-119767-91 W/CAP	SKRT470-R with Cap	16	KRT470-R hook only	16	91-010159-91	SCPF15	23
541~546	91-018340-91	SKRT545 with Cap		KRT545 hook only		91-018348-91	SCP545	23
541~546	91-018482-91	SKRT545S with Cap		KRT545S hook only		91-018348-91	SCP545	23
544-720	91-018340-91	SKRT545 with Cap		KRT545 hook only		91-018348-91	SCP545	23
544-720	91-018482-91	SKRT545S with Cap		KRT545S hook only		91-018348-91	SCP545	23
551~555	91-018340-91	SKRT545 with Cap		KRT545 hook only		91-018348-91	SCP545	23
551~555	91-018482-91	SKRT545S with Cap		KRT545S hook only		91-018348-91	SCP545	23
571/574/591	91-263490-91 W/CAP	SKRT592V2-S with Cap ADJ		KRT592V2-S hook only ADJ		91-263489-91	SCPF572	23
571/574/591	91-263495-91 W/CAP	SKRT592V2-R with Cap ADJ	16	KRT592V2-R hook only ADJ	16	91-263489-91	SCPF572	23
591~596	91-018340-91	SKRT545 with Cap		KRT545 hook only		91-018348-91	SCP545	23
591~596	91-018482-91	SKRT545S with Cap		KRT545S hook only		91-018348-91	SCP545	23
871-893	91-010165-91	SKRT151S with Cap		KRT151S hook only		91-010159-91	SCPF15	23
871-893	91-010850-91 W/CAP	SKRT145 with Cap		KRT145 hook only		91-010159-91	SCPF15	23
871-893	91-010896-91 W/CAP	SKRT191 with Cap		KRT191 hook only		91-010159-91	SCPF15	23
1181/1183	91-262250-91 W/BC	KHS1183-SP	7			91-262377-91	SC82-JNS N	25
1240C/D	91-018340-91 W/CAP	SKRT545 with Cap		KRT545 hook only		91-018348-91	SCP545	23
1241~1246	91-140539-91 W/CAP	SKRT1242-R with Cap	19	KRT1242-R hook only	19	91-018348-91	SCP545	23

Teflon HOOK BASE TEFLON

DLC HOOK BASE DLC COATING
MINIMAL OIL

Ti HOOK BASE
TITANIUM COATING

ADJ ADJUSTABLE STRONG
NEEDLE GUARD

N WITH NON SLIP SPRING

* = EXCLUSIVE ITEMS

PFAFF (百福)								
MACHINE (机器)	HOOK (旋梭)					BOBBIN CASE & CAP (梭壳 & 梭帽)		
	PART NO. (配件型号)	KOBAN NO.1 (佐文型号1)	PAGE	KOBAN NO.2 (佐文型号2)	PAGE	PART NO. (配件型号)	KOBAN NO. (佐文型号)	PAGE
1242-720	91-140538-91 W/O CAP	SKRT1242-S with Cap		KRT1242-S hook only		91-018348-91	SCP545	23
1242-720	91-140539-91 W/CAP	SKRT1242-R with Cap	19	KRT1242-R hook only	19	91-018348-91	SCP545	23
1242-748	91-140538-91 W/O CAP	SKRT1242-S with Cap		KRT1242-S hook only		91-018348-91	SCP545	23
1242-748	91-140539-91 W/CAP	SKRT1242-R with Cap	19	KRT1242-R hook only	19	91-018348-91	SCP545	23
1244-720B	91-140538-91 W/O CAP	SKRT1242-S with Cap		KRT1242-S hook only		91-018348-91	SCP545	23
1290C/D	91-018340-91 W/CAP	SKRT545 with Cap		KRT545 hook only		91-018348-91	SCP545	23
1571/1574/1591	91-263490-91 W/CAP	SKRT592V2-S with Cap ADJ		KRT592V2-S hook only ADJ		91-263489-91	SCPF572	23
1571/1574/1591	91-263495-91 W/CAP	SKRT592V2-R with Cap ADJ	16	KRT592V2-R hook only ADJ	16	91-263489-91	SCPF572	23
2081/2083	91-262250-91 W/BC	KHS1183-SP	7			91-262377-91	SC82-JNS N	25
3114	91-008250-91 W/O BC	KRP3114				91-008243-91	SC70-31	
3115	91-008250-91 W/O BC	KRP3114				91-008243-91	SC70-31	
3116	91-120710-91 W/O BC	KRP3116				91-008243-91	SC70-31	
3125A/B	91-006560-91	SH-P1	22					
3125C	91-006694-91	SH-P2	22					
3135A/B	91-006560-91	SH-P1	22					
3135C	91-006694-91	SH-P2	22					
3136A/B	91-006560-91	SH-P1	22					
3136C	91-006694-91	SH-P2	22					
3331A/B	91-006560-91	SH-P1	22					
3331C	91-006694-91	SH-P2	22					
3334~3337A/B	91-006560-91	SH-P1	22					
3334~3337A/B	91-006694-91	SH-P2	22					
3834	91-263490-91	SKRT592V2-S with Cap ADJ		KRT592V2-S hook only ADJ		91-263489-91	SCPF572	23
34-705-915/34-915-944/ 34C,D(S,L)	91-006694-91	SH-P2	22					
34-705A,B(S,L)/ 34-900/34A,B(S,L)	91-006560-91	SH-P1	22					
KSM-200	91-135660-91	KHS20-RPNG	5			99-135658-91	SC34-L	26

PRECIOUS (匯寶)								
MACHINE (机器)	HOOK (旋梭)					BOBBIN CASE & CAP (梭壳 & 梭帽)		
	PART NO. (配件型号)	KOBAN NO.1 (佐文型号1)	PAGE	KOBAN NO.2 (佐文型号2)	PAGE	PART NO. (配件型号)	KOBAN NO. (佐文型号)	PAGE
PC6-1		KHS12-S	2				SC31	24
PC5550/6150/8500/ 8700/8700G		KHS12-S	2				SC31	24
PC5550H/6150A/ 8500H/8700H		KHS12-R	1				SC31	24
PC7200B		KHS12-SPD2	3				SC31-NS N	24
PC8842H/8842L		KRT842H-S	11					
PC8845H/8845L		SKRT845BK with Cap	12	KRT845BK hook only	12		SCP-842BK	23
PC8872H		KRT872L	13					

Teflon 特氟隆内釜

DLC 像鑽石一樣堅硬的石炭塗層内釜

Ti 鈦塗層

ADJ 护针片調整旋梭

N 附防止空轉彈簧片

* = EXCLUSIVE ITEMS

PRECIOUS (匯寶)

MACHINE (機器)	HOOK (旋梭)					BOBBIN CASE & CAP (梭壳 & 梭帽)		
	PART NO. (配件型号)	KOBAN NO.1 (佐文型号1)	PAGE	KOBAN NO.2 (佐文型号2)	PAGE	PART NO. (配件型号)	KOBAN NO. (佐文型号)	PAGE
PC8875H		SKRT875LK with Cap		KRT875LK hook only			SCP-LBK	
PC9000-D3		KHS12-SPD2	3				SC31-NS N	24
PC9000-D3/9891H-D3/ PC9892H-D3		KHS12-RP	1				SC31-NS N	24
PC9302/9303		KHS20-RMP	4				SC33-LNS N	26
PC9820-D2/9891G-D3/ 9892-D3/9896-D3		KHS12-SPD2	3				SC31-NS N	24
PC9891GH-7-D3		KHS12-GTHPD	1				SC31-NS N	24

PRINCE

MACHINE (機器)	HOOK (旋梭)					BOBBIN CASE & CAP (梭壳 & 梭帽)		
	PART NO. (配件型号)	KOBAN NO.1 (佐文型号1)	PAGE	KOBAN NO.2 (佐文型号2)	PAGE	PART NO. (配件型号)	KOBAN NO. (佐文型号)	PAGE
PLM-100		KRT-LS2R	13					

PROTEX (通宇)

MACHINE (機器)	HOOK (旋梭)					BOBBIN CASE & CAP (梭壳 & 梭帽)		
	PART NO. (配件型号)	KOBAN NO.1 (佐文型号1)	PAGE	KOBAN NO.2 (佐文型号2)	PAGE	PART NO. (配件型号)	KOBAN NO. (佐文型号)	PAGE
GC39-1/628/5550		KHS12-S	2				SC31	24
GG20U		KR24U-42	9				SC35	24
TY-1130M/2000/ -6180M/-8500		KHS12-S	2				SC31	24
TY-1130H		KHS12-GTH	1				SC31	24
TY2000-5/-6		KHS12-GTH	1				SC31	24
TY-6180H		KHS12-GTH	1				SC31	24
TY-B211-413		KHS12-SP					SC31-NS N	24
TY-B211-415		KHS12-GTHPD	1				SC31-NS N	24
TY-B721-3		KHS12-SD	2				SC31	24
TY-B721-5		KHS12-RD	1				SC31	24
TY-B842-3		KRT842F-S	11					
TY-B845-403		SKRT845KC with Cap	12	KRT842KC hook only	12		SCP-842BKC	23
TY-B875-5		SKRT875LK with Cap		KRT875LK hook only			SCP-LBK	

RICHPEACE (富怡)

MACHINE (機器)	HOOK (旋梭)					BOBBIN CASE & CAP (梭壳 & 梭帽)		
	PART NO. (配件型号)	KOBAN NO.1 (佐文型号1)	PAGE	KOBAN NO.2 (佐文型号2)	PAGE	PART NO. (配件型号)	KOBAN NO. (佐文型号)	PAGE
RPEB-CL/-FN/-MC		KHS12-RY	1				SC35-NS N	24
		KHS12-RYP	1				SC34-2NS N	24
RPEC-T		KHS12-RYP	1				SC35-NS N	24
			1				SC34-2NS N	24
RPED-CS/-FN/-MC/-TC		KHS12-RYP	1				SC35-NS N	24
			1				SC34-2NS N	24
RPED-FH		KHS12-RYPOEOJ2	2				SC35-NS N	24
			2				SC34-2NS N	24

Teflon HOOK BASE TEFLON

DLC HOOK BASE DLC COATING
MINIMAL OIL

Ti HOOK BASE
TITANIUM COATING

ADJ ADJUSTABLE STRONG
NEEDLE GUARD

N WITH NON SLIP SPRING

* = EXCLUSIVE ITEMS

RICHPEACE (富怡)								
MACHINE (機器)	HOOK (旋梭)					BOBBIN CASE & CAP (梭壳 & 梭帽)		
	PART NO. (配件型号)	KOBAN NO.1 (佐文型号1)	PAGE	KOBAN NO.2 (佐文型号2)	PAGE	PART NO. (配件型号)	KOBAN NO. (佐文型号)	PAGE
RPMR		KHS12-RYP	1				SC35-NS N	24
			1				SC34-2NS N	24
RPQ-E		KHS12-RYP	1				SC35-NS N	24
			1				SC34-2NS N	24
RPQ-E/-ST		KHS20-RYP	5				SC35-LNS N	26
RPS-AT		KHS12-SPD2	3				SC31-NS N	24

SANGOOD (双角)								
MACHINE (機器)	HOOK (旋梭)					BOBBIN CASE & CAP (梭壳 & 梭帽)		
	PART NO. (配件型号)	KOBAN NO.1 (佐文型号1)	PAGE	KOBAN NO.2 (佐文型号2)	PAGE	PART NO. (配件型号)	KOBAN NO. (佐文型号)	PAGE
GC31/33/34		KHS12-S	2				SC31	24
GC32		KHS12-SPD2	3				SC31-NS N	24
GC40-1/45-1		KHS12-S	2				SC31	24
GF11001		KRP41-LH	10				SC70-2	27

SEIKO (精工)								
MACHINE (機器)	HOOK (旋梭)					BOBBIN CASE & CAP (梭壳 & 梭帽)		
	PART NO. (配件型号)	KOBAN NO.1 (佐文型号1)	PAGE	KOBAN NO.2 (佐文型号2)	PAGE	PART NO. (配件型号)	KOBAN NO. (佐文型号)	PAGE
BBW SERIES	994485/60482	KRT467						
BBWP-28BL/-BTFL	14505	KRT8-LPS	19					
BBWP-8BL/-BTFL	14005	KRT8-LPR	19					
BEW SERIES	967022/61019	KRT467L	19					
BSC-8BL, -8BLH, -8BLV SERIES	61779/855782*	KHS20-GTVG2*				17522	SC33-LNS3 N	26
BSC-8B, -8BV SERIES	61846/855849*	KR69-V2*				17034	SC39-14	24
CH-2B, -6B, -7B, -8B/-BTFL	28837C	KSP204	18					
CK-1	2530	KRT133	17					
CW SERIES	13086	KRT31-11S	15					
H-2B, -2BL	18849	KHS20-RM3	4			18550	SC33-LNS N	26
H-2BL-AE-1	026543C/24540C W/BC	KHS20-GTB	4					26
HC-2B	17033C W/BC	KR69-V	9			17318	SC39-14NS N	24
	18982C W/BC	KR69-VP	9				SC39-NS N	24
HC-2BL/-1	17520 W/BC	KHS20-GTVG	4			17522	SC33-LNS3 N	26
	18849C W/BC	KHS20-RM3	4			18550	SC33-LNS N	26
HCL-2BL	687085C/19082 W/BC	KHS20-R1E	4					SC33-LNS3 N
HCLH-2BL	17520 W/BC	KHS20-GTVG	4			17522	SC33-LNS3 N	26
JW-28BL-20	70140	KRT14-5-O	17					
JW-28BLC	95773	KRT14-5-O-C						
JW-8BL-20/-30	143143/70140	KRT14-5-O	17	KRT14-5-O2				
JW-8BLA-30-3, -28BLA-30-3	942664/70661	KRT14-5H-O						
JW-8BLC	95773	KRT14-5-O-C						
LSC-8B	17033C W/BC	KR69-V	9			17034	SC39-14	24
LCW-8BL/-1, -8BLV/-1, -28BL	13719	KRT8-BL	19					
LCW-8BL/-1, -8BLV/-1, -28BL (FOR THICK THREAD)	13719-A	KRT8-BLB						
LCW-8BL-1-TA	13703-A*	KRT8-BLB2-R*						
LCWN-8BL/-CB/-TA/-CB-TA, -8BLV/-CB	13719	KRT8-BL	19					

Teflon 特氟隆内釜

DLC 像鑽石一樣堅硬的石炭塗層内釜

Ti 鈦塗層

ADJ 护针片調整旋梭

N 附防止空轉彈簧片

* = EXCLUSIVE ITEMS

SEIKO (精工)

MACHINE (机器)	HOOK (旋梭)					BOBBIN CASE & CAP (梭壳 & 梭帽)		
	PART NO. (配件型号)	KOBAN NO.1 (佐文型号1)	PAGE	KOBAN NO.2 (佐文型号2)	PAGE	PART NO. (配件型号)	KOBAN NO. (佐文型号)	PAGE
LHPW-28BL	14119	SKRT8-LPK-2 with Cap		KRT8-LPK hook only		158509C	SCP26-L	
LHPW-8BL-1	14119	SKRT8-LPK-2 with Cap		KRT8-LPK hook only				
LHPW-8B-1	14175	SKRT470-RH with Cap	16	KRT470-RH hook only	16		SCPF15H	23
LHPW-8B-1-SF-LP	14175	SKRT470-RH with Cap	16	KRT470-RH hook only	16			
LHPW-8BL-1-LP	14119	SKRT8-LPK-2 with Cap		LRT8-LPK hook only		158509C	SCP26-L	
LHPWN-8B-3-SF-LP	14175	SKRT470-RH with Cap	16	KRT470-RH hook only	16		SCPF15H	23
LHPWN-8B-3-TA-SF-LP	14175	SKRT470-RH with Cap	16	KRT470-RH hook only	16			
LLW-28, -28BL	15502	KRT-LSS	14					
LLW-28BL/CS	34104/34110	KRT8-LCS-CS	13					
LLW-28BLC/CS	34754	KRT8-LCI2-S	13					
LLW-28BL-TA, -28L-TA	15232	KRT-LSRB	14					
LLW-28L	15502	KRT-LSS	14					
LLW-8BL	15040	KRT-LSR	13					
LLW-8BL/CS	34041/34075	KRT8-LCR-CS	13					
LLW-8BLC/CS	34754	KRT8-LCI2-S	13					
LLW-8BL-TA	15232	KRT-LSRB	14					
LLW-8L	15040	KRT-LSR	13					
LLW-8L-TA	15232	KRT-LSRB	14					
LLWH-28BL/CS	34104/34110	KRT8-LCS-CS	13					
LLWH-28BL-TA	15232	KRT-LSRB	14					
LLWN-8BL/CS	34104/34110	KRT8-LCS-CS	13					
LPW-26, -26B, -27, -27B, -28, -28B	12530	KRT31-SG						
LPW-26L, -26BL, -27L, -27BL, -28L, -28BL	14505	KRT8-LPS	19					
LPW-27BK	12856	SKRT31-SKG with Cap	15	KRT31-SKG hook only	15	12856-9C	SCP31-K	
LPW-27BLC	36902	KRT26-LPC						
LPW-27BLK, -28BLK	14706	SKRT8-LPK with Cap	20	KRT8-LPK hook only	20	147069C	SCP-BLP	23
LPW-6, -6B, -7, -7B, -8, -8B	12032	KRT31-RG	15					
LPW-6L, -6BL, -7L, -7BL, -8L, -8BL	14005/546008	KRT8-LPR	19					
LPWN-8BL	14005/546008	KRT8-LPR	19					
LPWN-28BL, -28L	14505	KRT8-LPS	19					
LPWN-28BLC, -8BLC	40854	KRT26-LPC2	19					
LSC-8BL, -8BLV-1, -8BLH-1	17520	KHS20-GTVG	4			17522/18850	SC33-LNS3 N	26
LSC-8BV-1, -8B-2, -8BV-2	17033C W/BC	KR69-V	9			17034	SC39-14	24
LSC-8BHC/-BT/-BTFL, -8BVC	17318C W/BC	KR69-V	9			17318	SC39-14NS N	24
LSW-6L	15040	KRT-LSR	13					
LSW-26BL	15040	KRT-LSR	13					
LSW-26BL-G/ -R	15850	SKRT26-L with Cap		KRT26-L hook only		15850-9C	SCP26-L	
LSW-6LG, -7LG	15120	SKRT26-LR with Cap		KRT26-LR hook only		15850-09		

Teflon HOOK BASE TEFLON

DLC HOOK BASE DLC COATING
MINIMAL OIL

Ti HOOK BASE
TITANIUM COATING

ADJ ADJUSTABLE STRONG
NEEDLE GUARD

N WITH NON SLIP SPRING

* = EXCLUSIVE ITEMS

SEIKO (精工)								
MACHINE (机器)	HOOK (旋梭)					BOBBIN CASE & CAP (梭壳 & 梭帽)		
	PART NO. (配件型号)	KOBAN NO.1 (佐文型号1)	PAGE	KOBAN NO.2 (佐文型号2)	PAGE	PART NO. (配件型号)	KOBAN NO. (佐文型号)	PAGE
LSW-6LG, -7LG	15850	SKRT26-L with Cap		KRT26-L hook only		15850-09	SCP26-L	
LSW-27BL, -28BL	15502	KRT-LSS	14					
LSW-27BLK, -28BLK	16407/242410	SKRT-BL with Cap		KRT-BL hook only		2424109C/16407-9	SCP-BL	
LSW-27BLKC	31303	SKRT-BLC with Cap		KRT-BLC hook only		2703069C/31304	SCP-BLC	
LSW-27L, -28L	15502	KRT-LSS	14	KRT-LS2S hook only				
LSW-8BL/CS, -28BL/CS	34104/34110	KRT8-LCS-CS	13					
LSW-28BL-TA	15232	KRT-LSRB	14					
LSW-7BL, -7BL-T, -7L, -7L-T	15040	KRT-LSR	13					
LSW-7LC, -7BLC, -8LC, -8BLC	30507	SKRT8-LC with Cap		KRT8-LC hook only		25651009	SCP-8LC	
LSW-7LTA, -8LTA	15232	KRT-LSRB	14					
LSW-7LTA, -8LTA	15232FG	KRT-LSSB						
LSW-8BL	15040	KRT-LSR	13					
LSW-8BL/CS	34041/34075	KRT8-LCR-CS	13					
LSW-8BLC	256510	SKRT8-LC with Cap		KRT8-LC hook only		25651009	SCP-8LC	
LSW-8BLC-CS1	34754/894757	KRT8-LCI2-S	13					
LSW-8BL-TA	15232	KRT-LSRB	14					
LSW-8BLV, -8BLM, -8BLVMF, -8BLVP, -8L, -8LM, -8L-T, -8LV, -8LVMF, -8LVP	15040	KRT-LSR	13					
LSWN-27BL-3	34104/34110	KRT8-LCS-CS	13					
LSWN-27BL-3	34041A	KRT8-LCR-CS	13					
LSWN-28BL-2/-3	34104/34110	KRT8-LCS-CS	13					
LSWN-28BL-2-TA/-3-TA	34041A	KRT8-LCR-CS	13					
LSWN-46BLR, -48BL	34104/34110	KRT8-LCS-CS	13					
LSWN-8BL, -8BLV	34041/34075	KRT8-LCR-CS	13					
LSWNH-28BL-20-1 SERIES	34104/34110	KRT8-LCS-CS	13					
LSWNH-8BL-20-1 SERIES	34075	KRT8-LCR-CS	13					
LSWNH-8BL-20-1-TA, -28BL-20-1-TA SERIES	34041A	KRT8-LCR-CS	13					
LTW-26,-27, -27B, -27BM	11124	KRT12-5B	11					
LTW-27BK	16291	SKRT12-5BK with Cap	11	KRT12-5BK hook only	11	16291-06	SCP-BK	23
LTW-27BLM	15502	KRT-LSS	14					
LW-27L	14505	KRT8-LPS	19					
LZ2-990, -992 SERIES	891023C/41020C W/BC	KHS20-TZS	6			891024/41021	SC34-LNS N	26
NCL-2BL	18849/015852C W/BC	KHS20-RM3	4			18550/015853	SC33-LNS N	26
PW-26B/-1, -27B, -28B	12032	KRT31-RG	15					
PW-6/-1, -7, -7B	12032	KRT31-RG	15					
PWB-22GW-1	37255	SKRT470-S with Cap		KRT470-S hook only		37255-7C	SCPF15	23
PWB-22GWC/-2-2QNU	37735	SKRT470C-S with Cap		KRT470C-S hook only		37735-7C	SCPF441	23
PWB-8GW-1	37255	SKRT470-R with Cap	16	KRT470-R hook only	16	37255-7C	SCPF15	23
PWB-8GWC-2/-2-QNU	37735	SKRT470C-S with Cap		KRT470C-S hook only		37735-7C	SCPF441	23

Teflon 特氟隆内釜

DLC 像鑽石一樣堅硬的石炭塗層内釜

Ti 鈦塗層

ADJ 护针片調整旋梭

N 附防止空軋彈簧片

* = EXCLUSIVE ITEMS

SEIKO (精工)

MACHINE (机器)	HOOK (旋梭)					BOBBIN CASE & CAP (梭壳 & 梭帽)		
	PART NO. (配件型号)	KOBAN NO.1 (佐文型号1)	PAGE	KOBAN NO.2 (佐文型号2)	PAGE	PART NO. (配件型号)	KOBAN NO. (佐文型号)	PAGE
PWB-8W	37255	SKRT470-S with Cap		KRT470-S hook only		37255-7C	SCPF15	23
SK-2B,-6,-6F,-7	1343C	KRT132	17					
SKM-26,-36	1526	KRT132-M	17					
SKZ-2B/-3/-23	1855	KRT132-SKZ	17					
SKZ-6/-6-3/-6-4	1855	KRT132-SKZ	17					
SKZ-6	296980	KRT132-SKZF						
SKZ-6B/-3	1855	KRT132-SKZ	17					
SKZ-6BR/-3	1855	KRT132-SKZ	17					
SLH-2B/-1/FH-1	721227/35224	KSP7-31	18					
SSH-8BLD, -8BLDC, STH-8BL, STH SERIES	18033*	KHS20-RPO*		KHS20-RPEM2AO	5	18045	SC33-LD N	26
STW-26, -27, -28, -8BM, -8M	10945	KRT11-5S						
STW-6, -7, -7B, -8, -8BV, -8V	10655	KRT11-5	11					
TH-6B	28091C	KSP204	18					
TH-8B	28837C	KSP204	18					

SewTech (缝科科技)

MACHINE (机器)	HOOK (旋梭)					BOBBIN CASE & CAP (梭壳 & 梭帽)		
	PART NO. (配件型号)	KOBAN NO.1 (佐文型号1)	PAGE	KOBAN NO.2 (佐文型号2)	PAGE	PART NO. (配件型号)	KOBAN NO. (佐文型号)	PAGE
ST-N3020B		SH311A	21					

SEWSTAR (荏旺)

MACHINE (机器)	HOOK (旋梭)					BOBBIN CASE & CAP (梭壳 & 梭帽)		
	PART NO. (配件型号)	KOBAN NO.1 (佐文型号1)	PAGE	KOBAN NO.2 (佐文型号2)	PAGE	PART NO. (配件型号)	KOBAN NO. (佐文型号)	PAGE
CW-267		SKRT167G with Cap		KRT167G hook only			SCP167	
CW-269		SKRT341-NR with Cap	20	KRT341-NR hook only	20		SCP545	23
CW-1105/-1125/-1135		KHS20-RST	5				SC34-LNS N	26
CW-1106/-1206		KR24-BICR					SC35	24
CW-1205/-1208/-1225/-1235		KHS20-RST	5				SC34-LNS N	26
CW-7105-S/-7205-S		KR24-BICR					SC35	24
CW-8105/-8205		KR24-BICR					SC35	24

SHANGGONG (上工)

MACHINE (机器)	HOOK (旋梭)					BOBBIN CASE & CAP (梭壳 & 梭帽)		
	PART NO. (配件型号)	KOBAN NO.1 (佐文型号1)	PAGE	KOBAN NO.2 (佐文型号2)	PAGE	PART NO. (配件型号)	KOBAN NO. (佐文型号)	PAGE
8800		KHS12-S	2				SC31	24
G15		KRP41-LH	10				SC70-2	27
GC0301/0601-1/505-1		KHS12-SD	2				SC82-JNS N	25
GC1-3/8-2/15-1/15-2		KHS12-S	2				SC31	24
GC15-3/15-4		KHS12-GTH	1				SC31	24
GC15-5-4D		KRT21	15					
GC22		KHS12-S	2				SC31	24
GC30-1/-2/-3		KHS12-S	2				SC31	24
GC45-1		KHS12-S	2				SC31	24
GC30-4-5D/555-4-5D		KHS12-SPD2	3				SC31-NS N	24
GC5550		KHS12-S	2				SC31	24

Teflon HOOK BASE TEFLON

DLC HOOK BASE DLC COATING
MINIMAL OIL

Ti HOOK BASE
TITANIUM COATING

ADJ ADJUSTABLE STRONG
NEEDLE GUARD

N WITH NON SLIP SPRING

* = EXCLUSIVE ITEMS

SHANGGONG (上工)								
MACHINE (機器)	HOOK (旋梭)					BOBBIN CASE & CAP (梭壳 & 梭帽)		
	PART NO. (配件型号)	KOBAN NO.1 (佐文型号1)	PAGE	KOBAN NO.2 (佐文型号2)	PAGE	PART NO. (配件型号)	KOBAN NO. (佐文型号)	PAGE
GD8-1/-4/-7		SKRT12-5LJKC-L1 with Cap		KRT12-5LJKC-L hook only			SCP-LJKC	
GD8-1/-4/-7		SKRT12-5LJKC-R1 with Cap		KRT12-5LJKC-R hook only				
GD9,GDB		KRT21	15					
GD2302		SH280	21				SC980N	29
GF108		KRP41-LH2	10				SC70-771	27

SICAMA (安機)								
MACHINE (機器)	HOOK (旋梭)					BOBBIN CASE & CAP (梭壳 & 梭帽)		
	PART NO. (配件型号)	KOBAN NO.1 (佐文型号1)	PAGE	KOBAN NO.2 (佐文型号2)	PAGE	PART NO. (配件型号)	KOBAN NO. (佐文型号)	PAGE
BEISLER842/YAZICI842		SKRT842C with Cap	11	KRT842KC hook only	11		SCP-842BC	23
BEISLER845/YAZICI845		SKRT845KC with Cap	12	KRT842KC hook only	12		SCP-842BKC	23
LT2-B842		KRT12-5BF	11					
LT2-B842-3/-5		KRT12-5M	11					
LT2-B842-380/-580		KRT12-5BFCI						
LT2-B845		SKRT12-5BK with Cap	11	KRT12-5BK hook only	11		SCP-BK	23
LT2-B845-3/-5		SKRT12-5MK with Cap	11	KRT12-5MK hook only	11		SCP-MK	23
LT2-B845-380/-580		SKRT12-5BFKC with Cap		KRT12-5BFKC hook only			SCP-842BKC	23
LT2-B848-3		KRT12-5M	11		11			
LT2-B848-380		KRT12-5BFCI						
LT2-B849-380		KRT12-5BFCI						
LT2-B872/-3/-5		KRT12-5LM	13		13			
LT2-B872-380		KRT12-5LMKCI	13		13			
LT2-B872-580		SKRT875LKC with Cap	14	KRT875LC hook only	14		SCP-LBKC	23
LT2-B875/-3/-5		SKRT12-5LMK with Cap	14	KRT12-5LMK hook only	14		SCP-LMK	23
LT2-B875-380/-580		SKRT12-5LMKC-1 with Cap		KRT12-5LMKC hook only			SCP-LMKC	

SINGER (勝家)								
MACHINE (機器)	HOOK (旋梭)					BOBBIN CASE & CAP (梭壳 & 梭帽)		
	PART NO. (配件型号)	KOBAN NO.1 (佐文型号1)	PAGE	KOBAN NO.2 (佐文型号2)	PAGE	PART NO. (配件型号)	KOBAN NO. (佐文型号)	PAGE
71	23503	SH51	21					
281	143342	KHS12-G	1					
281	143342FG	KHS12-S	2					
281	143342LS	KHS12-SOHO						
281	143342TS	KHS12-GN Teflon	1			52237	SC31	24
281	149172	KHS12-SAC						
281	34825	KHS12-SND						
281	545990	KHS12-SU2						
366	143342FG	KHS12-S	2					
369	239727	KHS20-SPNP				239728	SC369 N	
7-9	58525	KSP7-9	18					

Teflon 特氟隆內釜

DLC 像鑽石一樣堅硬的石炭塗層內釜

Ti 鈦塗層

ADJ 护针片調整旋梭

N 附防止空轉彈簧片

* = EXCLUSIVE ITEMS

SINGER (勝家)

MACHINE (機器)	HOOK (旋梭)					BOBBIN CASE & CAP (梭壳 & 梭帽)		
	PART NO. (配件型号)	KOBAN NO.1 (佐文型号1)	PAGE	KOBAN NO.2 (佐文型号2)	PAGE	PART NO. (配件型号)	KOBAN NO. (佐文型号)	PAGE
107G	210533SN/224460	KRP41-L				224441NS	SC70-2NS N	27
107G	210533H	KRP41-R	10			224441	SC70-2	27
107G	210533HSB	KRP41-R	10			224441M	SC70-2M	27
107G	224459	KRP41-S	10			241404NBL	SC70-2NS N	27
107U202	210533HSB	KRP41-R	10			224441M	SC70-2M	27
107U202	224459	KRP41-S	10			241404NBL	SC70-2NS N	27
107U202	210533H	KRP41-R	10			224441	SC70-2	27
107U202	210533SN/224460	KRP41-L				224441NS	SC70-2NS N	27
107W1/3/5/17	210533HSB	KRP41-R	10			224441M	SC70-2M	27
107W1/3/5/17	224459	KRP41-S	10			241404NBL	SC70-2NS N	27
107W1/3/5/17	210533H	KRP41-R	10			224441	SC70-2	27
107W1/3/5/17	210533SN/224460	KRP41-L				224441NS	SC70-2NS N	27
108K, 108U	224750	KRP108-R						
108K20, 108W1/20/21	224750/244088	KRP108-R						
110W-2	247675	SKRT19-R with Cap		KRT19-R hook only		241676	SCP18	
111W155/156	240558	KRT11-5	11					
112W110/115-139	240091	KRT12-5R						
112W115-139	237204	KRT12-5S						
112W140/145/146	248463	KRT12-4	11					
118W	235797	SKRT18-S with Cap		KRT18-S hook only		241676	SCP18	
119W	247675	SKRT19-R with Cap		KRT19-R hook only				
121C330AA, 121D330AA	239727	KHS20-SPNP				530198	SC33-LNS N	26
131W	244521	KRT31-11S	15					
131W	236121	KRT31-R	15					
131W	238250	KRT31-11R	15					
131W103/104/110/113	236121	KRT31-R	15					
132K	103123	KRT132	17					
133K	103120	KRT133	17					
136W	249118	SKRT136 with Cap		KRT136 hook only		241676	SCP18	
136W	264161	SKRT51 with Cap		KRT51 hook only				
138G102, 138W102	264161	SKRT51 with Cap		KRT51 hook only		241676	SCP18	
143W1	224443	KRP41-S	10			224441	SC70-2	27
144W, 145W	265093	KRT14-5						
144W, 145W	265093HP/265361HP	KRT14-5HP	17					
153K, 153W	238250	KRT31-11R	15					
1591D300G	544784	KHS12-SPUNS				52237NS	SC31-NS N	24
15K88	125292	SH15						
167G/W, 168W	264414	KRT18-R				241676	SCP18	
188U	546794	KR18	8					
191D200AA/300A/ 300AA/300BA	414126	KHS12-S	2			52237	SC31	24
195K, 196K	174046	KR18	8					
20U11/13/23	541674/541968	KR24-U	8					
20U31	410019	KR24U-31	9					
20U31/33/34	410140	KR24U-42S	9			541678	SC35-T	24
20U42/43, 20UX143	410054	KR24U-42	9					
20U142	410054	KR24U-42	9					

Teflon HOOK BASE TEFLON

DLC HOOK BASE DLC COATING
MINIMAL OIL

Ti HOOK BASE
TITANIUM COATING

ADJ ADJUSTABLE STRONG
NEEDLE GUARD

N WITH NON SLIP SPRING

* = EXCLUSIVE ITEMS

SINGER (勝家)								
MACHINE (機器)	HOOK (旋梭)					BOBBIN CASE & CAP (梭壳 & 梭帽)		
	PART NO. (配件型号)	KOBAN NO.1 (佐文型号1)	PAGE	KOBAN NO.2 (佐文型号2)	PAGE	PART NO. (配件型号)	KOBAN NO. (佐文型号)	PAGE
2110X104/106	510008	KRT211-L	19					
211A, 212A141BA/GA	554507	KRT12-5M	11					
211G146/151/157/157A/ 158/166/265/266	244711	KRT211						
211G155/156	240558	KRT11-5	11					
211G557/558/566A/ 866A/867A	510008	KRT211-L	19					
211GX109/114/117	510008	KRT211-L	19					
211GX110/115	244711	KRT211						
211U157/257	244711	KRT211						
211U165/166	240558	KRT11-5	11					
211U341/365	240558	KRT11-5	11					
211U566/866	510008	KRT211-L	19					
211U567/867	412307	KRT11-5LJR	13					
211UX157	244711	KRT211						
211UX566	510008	KRT211-L	19					
211UX567	412307	KRT11-5LJR	13					
211W151/155	240558	KRT11-5	11					
211X104/106	510008	KRT211-L	19					
212A143	281081	SKRT12-5MK with Cap	11	KRT12-5MK hook only	11	412440	SCP-MK	23
212A147	267357	KRT21	15					
212A939JA/JB	281049	KRT-LSR	13					
212G140/141/145/440	267357	KRT21	15					
212G440	514109	SKRT21-4 with Cap		KRT21-4 hook only		512551	SCP21	
212G539/541	510008	KRT211-L	19					
212GX106/114	510008	KRT211-L	19					
212GX4/5/6	267357	KRT21	15					
212LX670	267357	KRT21	15					
212U143A/144/443A/444	412433	SKRT21-K with Cap		KRT21-K hook only		412440	SCP-MK	23
212U41/141/442	267357	KRT21	15					
212U539A/839A	412307	KRT11-5LJR	13					
212U541A/841A	510008	KRT211-L	19					
212W140/145/146	267357	KRT21	15					
21W12/162/22W/30/72W	203290	SKRT72 with Cap				236853	SCP72	
21W162	203804	KRT51-11R						
21W180/182	238250	KRT31-11R	15					
220U22/23	414126	KHS12-S	2			52237	SC31	24
236G/W	263464	SKRT236 with Cap		KRT236 hook only		241676	SCP18	
236G120/124/125/ 130/131/132	263464	SKRT236 with Cap		KRT236 hook only				
269W	40028	SH61	21					
269W	40028CR	SH61CR	22					
271K	271421 LESS BC	KRP271				271785	SC70-27	
281-181/183/41	545990	KHS12-SU2				52237	SC31	24
291U, 391U	545990	KHS12-SU2						
31-15	12393	SH31	21					

Teflon 特氟隆内釜

DLC 像鑽石一樣堅硬的石炭塗層内釜

Ti 鈦塗層

ADJ 护针片調整旋梭

N 附防止空轉彈簧片

* = EXCLUSIVE ITEMS

SINGER (勝家)

MACHINE (机器)	HOOK (旋梭)					BOBBIN CASE & CAP (梭壳 & 梭帽)		
	PART NO. (配件型号)	KOBAN NO.1 (佐文型号1)	PAGE	KOBAN NO.2 (佐文型号2)	PAGE	PART NO. (配件型号)	KOBAN NO. (佐文型号)	PAGE
400W, 402W, 451K	143342FG	KHS12-S	2			52237	SC31	24
400W, 402W, 451K	143342	KHS12-R	4					
400W, 402W, 451K	143342LS	KHS12-SOHO						
400W, 402W, 451K	143342TS	KHS12-GN Teflon	1					
412U	554507	KRT12-5M	11					
412U141/141G	554824	KRT412-S	15					
431D200A	12393	SH31	21					
457A	417664	KRP457	10			502530	SC70-3	27
457A	282293	KRP457-W3ICC DLC	10					
457G	34822	KRP457-W	10					
457G	34822	KRP457-W3ICC DLC	10					
457U	417664	KRP457	10					
457U	417664	KRP457-W3ICC DLC	10					
469U	418505	SH469	21					
469U	418045	SH469-H						
46W	238250	KRT31-11R	15					
47W70	244521	KRT31-11S	15					
491D100GA/200GA	414126	KHS12-SU1		KHS12-2S	1	52237	SC31	24
491D300GA/308GA	414126	KHS12-SU1		KHS12-2S	1			
491UX100/110B/G/H	414430/544784	KHS12-SPUNS				52237NS	SC31-NS N	24
491UX200/210B/G/H	414430/544784	KHS12-SPUNS						
491UX300/310B/G/H	414430/544784	KHS12-SPUNS						
52K	264161	SKRT51 with Cap		KRT51 hook only		241676	SCP18	
52W22	264161	SKRT51 with Cap		KRT51 hook only				
52W30/31	238250	KRT31-11R	15					
569U	418505	SH469	21					
569U	418045	SH469-H						
569U1141/3141	418505-452	SH469TI Ti						
591C200AA	414126	KHS12-SU1		KHS12-2S	1	52237	SC31	24
591C300AA	414126	KHS12-SU1		KHS12-2S	1			
591C300GA	414430/544784	KHS12-SPUNS				52237NS	SC31-NS N	24
591D200	414430/544784	KHS12-SPUNS						
591D200AA	414126	KHS12-2S	1			52237	SC31	24
591D203/205	414126	KHS12-2S	1					
591D205AA	414126	KHS12-2S	1					
591D210BD/BF/GD/GF/GA	414430/544784	KHS12-SPUNS				52237NS	SC31-NS N	24
591D210GA	414430/544784	KHS12-SPUNS						
591D215	414430/544784	KHS12-SPUNS				52237	SC31	24
591D240AD/AF	414126	KHS12-2S	1					
591D240BF/GD/GF	414430/544784	KHS12-SPUNS				52237NS	SC31-NS N	24
591D300/GA	414430/544784	KHS12-SPUNS						
591D300AA	414126	KHS12-2S	1			52237	SC31	24
591D303AA	414126	KHS12-2S	1					
591D305AA	414126	KHS12-2S	1					
591D308AA	414126	KHS12-2S	1					
591D308AA	414126	KHS12-2S	1					

Teflon HOOK BASE TEFLON

DLC HOOK BASE DLC COATING
MINIMAL OIL

Ti HOOK BASE
TITANIUM COATING

ADJ ADJUSTABLE STRONG
NEEDLE GUARD

N WITH NON SLIP SPRING

* = EXCLUSIVE ITEMS

SINGER (勝家)								
MACHINE (机器)	HOOK (旋梭)					BOBBIN CASE & CAP (梭壳 & 梭帽)		
	PART NO. (配件型号)	KOBAN NO.1 (佐文型号1)	PAGE	KOBAN NO.2 (佐文型号2)	PAGE	PART NO. (配件型号)	KOBAN NO. (佐文型号)	PAGE
591D310BD/BF/GA/GD/GF	414430/544784	KHS12-SPUNS				52237NS	SC31-NS N	24
591D315/315GA	414430/544784	KHS12-SPUNS						
591D318BD/BF/GD/GF	414430/544784	KHS12-SPUNS						
591DUX100	414126	KHS12-2S	1			52237	SC31	24
591DX200GX	414430/544784	KHS12-SPUNS				52237NS	SC31-NS N	24
591E200G/210G	414430/544784	KHS12-SPUNS						
591UX100/220/312	414430/544784	KHS12-SPUNS				52237NBL	SC31-NS N	24
591UX313/BF/GF/GAE	414430/544784	KHS12-SPUNS						
591UX320GF	414430/544784	KHS12-SPUNS						
591V200A, 591V300A	414126	KHS12-2S	1			52237	SC31	24
600W	143342FG	KHS12-S	2					
601D100AD/AF/BD	414430/544784	KHS12-SPUNS				52237NBL	SC31-NS N	24
601D100BF/GD/GF	414430/544784	KHS12-SPUNS						
691D	368132	KHS12-SPU3				52237NS	SC31-NS N	24
691D100GD/D110GD/D150GD/ D200GD/D210GD/D250GD/ D300GD/D310GD/D350GD	414430/544784	KHS12-SPUNS						
72W12	203290	SKRT72 with Cap		KRT72 hook only		236853	SCP72	
95-40/96-40	127119T	KR21-G	8			52237	SC31	24
95-40/96-40	127119	KR21-R	8					
95-40/96-40	127119FG/144830FG/357271	KR21-S	8					

* = EXCLUSIVE ITEMS

SIRUBA (高林)

MACHINE (机器)	HOOK (旋梭)					BOBBIN CASE & CAP (梭壳 & 梭帽)		
	PART NO. (配件型号)	KOBAN NO.1 (佐文型号1)	PAGE	KOBAN NO.2 (佐文型号2)	PAGE	PART NO. (配件型号)	KOBAN NO. (佐文型号)	PAGE
BH790A	G190JK	KRP41-LH3ICC DLC	10			G209K	SC70-3WFLNS N	27
BH790B	G190JK	KRP41-LH3KICC DLC	10					
DL889-L2-□, DL889-M1-□, DL889-M2-□,	G121	KHS12-SPD2	3			G202	SC31-NS N	24
L818D-L1/M1/HI/HMI	G111	KHS12-2S	1			G201	SC31	24
L818-F1, L818F-DM1/ DM1A, L818F-F1/-L1	G111	KHS12-2S	1					
L818F-H1, L818F-H1A, L818-H1C	G112	KHS12-R	1					
L818F-H1-□	G125	KHS12-RP	1			G202	SC31-NS N	24
L818F-K1	G111	KHS12-2S	1			G201	SC31	24
L818F-K1/M1-□	G121	KHS12-SPD2	3			G202	SC31-NS N	24
L818F-L1-□	G121	KHS12-SPD2	3					
L818F-M1/HM1/M1A/M1C	G111	KHS12-2S	1			G201	SC31	24
L818F-NM1-□	G121	KHS12-SPD2	3			G202	SC31-NS N	24
L818F-RM1	G111	KHS12-2S	1			G201	SC31	24
L819-X1	G112	KHS12-R	1					
L819-X1-10/13/13P	G125	KHS12-RP	1			G202	SC31-NS N	24
L819-X2	G131	KHS20-RM2	4			G204	SC33-L	26
L819-X2-10/13/13P	G132	KHS20-RMPN	4			G205	SC33-LNS N	26
L918-H1	G112	KHS12-R	1			G201	SC31	24
L918-H1-□	G125	KHS12-RP	1			G202	SC31-NS N	24
L918-H1A/-H1C	G112	KHS12-R	1			G201	SC31	24
L918-HM1/-HM1A/-L1	G111	KHS12-2S	1					
L918-L1-□	G121	KHS12-SPD2	3			G202	SC31-NS N	24
L918-M1, L918-M1A/-MIC	G111	KHS12-2S	1			G201	SC31	24
L918-M1-□	G121	KHS12-SPD2	3			G202	SC31-NS N	24
LBHS-1790S	G190JK	KRP41-LH3ICC DLC	10			G209K	SC70-3WFLNS N	27
LBHS-1792K(FOR KNITS)	G191JK	KRP41-LH3KICC DLC	10					
LBHS-1795A/1795S	G190JK	KRP41-LH3ICC DLC	10					
LKS-1900ANFS (FOUNDATION)	G186JK	SH280	21			G260JK	SC980-2 N	29
LKS-1900ANHS (HEAVY MATERIAL)	G185JK	SH282	21					
LKS-1900ANSS	G186JK	SH280	21					
LKS-1902ANHS (HEAVY MATERIAL)	G185JK	SH282	21					
LKS-1902ANSS	G186JK	SH280	21					
LKS-1903ANSS301	G186K	SH280	21	SH282	21			
LKS-1903ANSS302	G186K	SH280	21	SH282	21			
P717, P727	G151	KRT31-NR	15					
PK533□-L	G181	SH181	21			G207	SC181 N	28
PK533M, H	G182	SH430-H	21			G208	SC430 N	29
PK588A-M, PK588-M,H, PK599-M,H	G183	SH181H	21			G207	SC181 N	28
R718-01/-02, R728-□□	G152-A	SKRT470-R with Cap	16	KRT470-R hook only	16	G401	SCPF15	23

Teflon HOOK BASE TEFLON

DLC HOOK BASE DLC COATING
MINIMAL OIL

Ti HOOK BASE
TITANIUM COATING

ADJ ADJUSTABLE STRONG
NEEDLE GUARD

N WITH NON SLIP SPRING

* = EXCLUSIVE ITEMS

SIRUBA (高林)								
MACHINE (機器)	HOOK (旋梭)					BOBBIN CASE & CAP (梭壳 & 梭帽)		
	PART NO. (配件型号)	KOBAN NO.1 (佐文型号1)	PAGE	KOBAN NO.2 (佐文型号2)	PAGE	PART NO. (配件型号)	KOBAN NO. (佐文型号)	PAGE
R718-01-□	G155-A	SKRT470C-R with Cap	16	KRT470C-R hook only	16	G403	SCPF441	23
R718-01H	G153-A	SKRT470-RHH with Cap		KRT470-RH hook only		G412	SCPF441H	
R728-□□-□	G155-A	SKRT470C-R with Cap	16	KRT470C-R hook only	16	G403	SCPF441	23
R728-□□H	G153-A	SKRT470-RHH with Cap		KRT470-RH hook only		G412	SCPF441H	
T828-41-□□□□	G162-A	SKRT842FK-S with Cap	12	KRT842FK-S hook only	12	G406	SCP-842BC	23
T828-41-□□□HL	G167	KRT842H-S	11					
T828-41-□□□LL/-41-□□□ML	G161	KRT842F-S	11					
T828-42-□□□□□/□□	G164-A	SKRT842C with Cap	11	KRT842KC hook only	11	G406	SCP-842BC	23
T828-42-□□□HL	G167	KRT842H-S	11					
T828-42-□□□HL/□□	G163	KRT842CI	11					
T828-42-□□□LL, T828-42-□□□ML	G161	KRT842F-S	11					
T828-42-□□□ML/□□	G163	KRT842CI	11					
T828-42-□□□□	G161	KRT842F-S	11					
T828-45-□□□H, T828-45-□□□M, T828-45-□□□X	G169-A	SKRT845BK with Cap	12	KRT845BK hook only	12	G409	SCP-842BK	23
T828-45-H-U, T828-45 -M-U, T828-X-U	G170	KRT842KC	11			G410	SCP-842BKC	23
T828-47-□□□□	G162-A	SKRT842FK-S with Cap	12	KRT842FK-S hook only	12	G406	SCP-842BC	23
T828-47-□□□□□/□□	G164-A	SKRT842C with Cap	11	KRT842KC hook only	11			
T828-47-□□□□LL	G161	KRT842F-S	11					
T828-47-□□□□LL/□□	G163	KRT842CI	11					
T828-47-HL-U, T828-47-ML-U	G163	KRT842CI	11					
T828-47-U	G164-A	SKRT842C with Cap	11	KRT842KC hook only	11	G406	SCP-842BC	23
T828-48-□□□L	G169-A	SKRT845BK with Cap	12	KRT845BK hook only	12	G409	SCP-842BK	23
T828-72-□□□H/□□	G168-A	SKRT872LC with Cap	14	KRT875LC hook only	14	G411	SCP-LBC	23
T828-72-□□□HL	G165	KRT872L	13					
T828-72-□□□M/□□	G168-A	SKRT872LC with Cap	14	KRT875LC hook only	14	G411	SCP-LBC	23
T828-72-□□□ML	G165	KRT872L	13					
T828-75-□□□H	G166-A	SKRT875LK with Cap		KRT875LK hook only		G407	SCP-LBK	
T828-75-□□□H/□□	G168-A1	SKRT875LKC with Cap	14	KRT875LC hook only	14	G408	SCP-LBKC	23
T828-75-□□□M	G166-A	SKRT875LK with Cap		KRT875LK hook only		G407	SCP-LBK	
T828-75-□□□M/□□	G168-A1	SKRT875LKC with Cap	14	KRT875LC hook only	14	G408	SCP-LBKC	23

Teflon 特氟隆内釜

DLC 像鑽石一樣堅硬的石炭塗層内釜

Ti 鈦塗層

ADJ 护针片調整旋梭

N 附防止空軋彈簧片

* = EXCLUSIVE ITEMS

SIRUBA (高林)

MACHINE (机器)	HOOK (旋梭)					BOBBIN CASE & CAP (梭壳 & 梭帽)		
	PART NO. (配件型号)	KOBAN NO.1 (佐文型号1)	PAGE	KOBAN NO.2 (佐文型号2)	PAGE	PART NO. (配件型号)	KOBAN NO. (佐文型号)	PAGE
T828-75-□□□X	G166-A	SKRT875LK with Cap		KRT875LK hook only		G407	SCP-LBK	
T828-75-□□□X/□□	G168-A1	SKRT875LKC with Cap	14	KRT875LC hook only	14	G408	SCP-LBKC	23
UC918-H11	G154-A	SKRT341G with Cap	20	KRT341G hook only	20	G402	SCP545	23
UF916-X2	G171	KRT12-5LMC	13					
UF916-X2-□	G173	KRT12-5LMKC-CI-NS						
UF918-X2, -X2-□	G175	KRT467						
UF926-X2-□	G171	KRT12-5LMC	13					
UF926-X2-□-□	G173	KRT12-5LMKC-CI-NS						
UF926-X2L-□	G172-A	SKRT12-5LMKC-C with Cap		KRT12-5LMKC-C hook only		G220	SCP-LMC	
UF928-X2, -X2-□	G175	KRT467						
YF616-X2	G131	KHS20-RM2	4			G204	SC33-L	26
YF616-X2-□	G132	KHS20-RMPN	4			G205	SC33-LNS N	26
YF619-X2	G131	KHS20-RM2	4			G204	SC33-L	26
YF619-X2-□	G132	KHS20-RMPN	4			G205	SC33-LNS N	26

STAGER (津久井)

MACHINE (机器)	HOOK (旋梭)					BOBBIN CASE & CAP (梭壳 & 梭帽)		
	PART NO. (配件型号)	KOBAN NO.1 (佐文型号1)	PAGE	KOBAN NO.2 (佐文型号2)	PAGE	PART NO. (配件型号)	KOBAN NO. (佐文型号)	PAGE
SE-12		KR24-T					SC35-T	24
SZ-21		KR24-T						
SZ-21-1BN/-1BNL		KHS20-TZ	6				SC34-L	26
SZ-21-1N/-2N/-3N/ -4N/-6N/-7N/-8N		KR24-T					SC35-T	24
SZ-21-3NL/-3BNL		KHS20-TZ	6					
SZ-21-4NL/-4BNL		KHS20-TZ	6					
SZ-21-5		KHS20-TZ	6				SC34-L	26
SZ-21-5-3N/-3NL/-4N/ -4NL/-5N/-5NL/-5WN		KHS20-TZ	6					
SZ-25N		KR24-T						
SZ-72N		KR24-T					SC35-T	24
SZ-72N-8N		KR24-T						
SZ-310-5-1N/-1WN/-3N/-4N		KRP457-W	10					
SZ-310-1N/-3N/-4N/-11N		KRP457-W	10				SC70-3	27

SUNNUN (信能)

MACHINE (机器)	HOOK (旋梭)					BOBBIN CASE & CAP (梭壳 & 梭帽)		
	PART NO. (配件型号)	KOBAN NO.1 (佐文型号1)	PAGE	KOBAN NO.2 (佐文型号2)	PAGE	PART NO. (配件型号)	KOBAN NO. (佐文型号)	PAGE
DY-637		KHS20-R	4				SC33-L	26
EB-883		KR24	8				SC35	24
YU-740		KHS20-R	4				SC33-L	26

SUNSTAR (日星)

MACHINE (机器)	HOOK (旋梭)					BOBBIN CASE & CAP (梭壳 & 梭帽)		
	PART NO. (配件型号)	KOBAN NO.1 (佐文型号1)	PAGE	KOBAN NO.2 (佐文型号2)	PAGE	PART NO. (配件型号)	KOBAN NO. (佐文型号)	PAGE
BH/3000/3100	07-029A-300G/ CHK-HA000800	KRP800BTI Ti	10	KRP800BICC DLC		07-029A-300G/ CHK-HC000800	SC70-3WFLNS N	27
DPK-2/-3	07-011A-2302	KRP41-S	10			07-016A-2302	SC70-2	27

Teflon HOOK BASE TEFLON

DLC HOOK BASE DLC COATING
MINIMAL OIL

Ti HOOK BASE
TITANIUM COATING

ADJ ADJUSTABLE STRONG
NEEDLE GUARD

N WITH NON SLIP SPRING

* = EXCLUSIVE ITEMS

SUNSTAR(日星)								
MACHINE (机器)	HOOK (旋梭)					BOBBIN CASE & CAP (梭壳 & 梭帽)		
	PART NO. (配件型号)	KOBAN NO.1 (佐文型号1)	PAGE	KOBAN NO.2 (佐文型号2)	PAGE	PART NO. (配件型号)	KOBAN NO. (佐文型号)	PAGE
KLZ-371	07-012A-3710	KR24	8				SC35	24
KM-1060BL	07-144A-106L	KRT467						
KM-123A	07-007A-123A/ CHK-HA001900	KHS12-S	2			07-106A-123A	SC31	24
KM-137A	07-007A-123A/ CHK-HA001900	KHS12-S	2			07-106A-123A	SC31	24
KM-123B	07-007A-123B	KHS12-GTH	1			07-106A-123A	SC31	24
KM-137B	07-007A-123B	KHS12-GTH	1					
KM-146BL	07-007A-146L/CHK-HA003300	KHS20-GTB	4			07-106A-146L	SC33-L	26
KM-235A	07-003A-270A/CHK-HA000700	KHS12-SPD2	3			07-106A-2700	SC31-NS N	24
KM-235B	07-003A-270B/CHK-HA000900	KHS12-GTHPD	1			07-004A-3500	SC82-JNS N	25
KM-250A	07-007A-123A/CHK-HA001900	KHS12-S	2			07-106A-123A	SC31	24
KM-250A-7	07-003A-270A/CHK-HA000700	KHS12-SPD2	3			07-106A-2700	SC31-NS N	24
KM-250B	07-007A-123B	KHS12-GTH	1			07-106A-123A	SC31	24
KM-250B-7	07-003A-270B/CHK-HA000900	KHS12-GTHPD	1			07-004A-3500	SC82-JNS N	25
KM-250BL-7K/-7S	07-024A-64L7/CHK-HA001300	KHS20-RMP	4			07-026A-64L7	SC33-LNS N	26
KM-340BL	07-007A-146L/CHK-HA003300	KHS20-GTB	4			07-106A-146L	SC33-L	26
KM-341BL	07-024A-64L7/CHK-HA001300	KHS20-RMP	4			07-026A-64L7	SC33-LNS N	26
KM-350A	07-003A-350A/CHK-HA002000	KHS12-SD	2				SC82-J	25
KM-350A-7	07-001A-357A/CHK-HA002100	KHS12-SPD2	3			07-004A-3500	SC82-JNS N	25
KM-350B	07-003A-350B/CHK-HA002200	KHS12-GTH	1				SC82-J	25
KM-350B-7	07-003A-270B/CHK-HA000900	KHS12-GTHPD	1			07-004A-3500	SC82-JNS N	25
KM-360J	GP-000814-00/CHK-HA000400	KHS20-RMP	4			GP-012152-00	SC33-LNS N	26
KM-380	07-004A-3800	KR21-GTPDE	8			07-005A-3800	SC81-2	24
KM-380BL	07-003A-380L/CHK-HA001400	KHS20-GTVG	4			07-106A-146L	SC33-L	26
KM-390BL	07-011A-3900/CHK-HA001500	KRT8-BL	19					
KM-506	07-003A-270A/CHK-HA000700	KHS12-SPD2	3			07-106A-2700	SC31-NS N	24
KM-530/-530-7	07-003A-350A/CHK-HA002000	KHS12-SD	2				SC82-J	25
KM-560	07-001A-5600/CHK-HA002500	KRT-LSR	13					
KM-560-7	07-001A-5607/CHK-HA002400	KRT-LS2CI-S	13					
KM-570BL/-572BL	07-001A-5600/CHK-HA002500	KRT-LSR	13					
KM-590B/-591BL	07-007A-590L	KHS20-HPEW	4			07-006A-590L	SC33-LD N	26
KM-640BL	07-007A-640L	KHS20-RM2	4			07-106A-146L	SC33-L	26
KM-640BL-7	07-024A-64L7/CHK-HA001300	KHS20-RMP	4			07-026A-64L7	SC33-LNS N	26
KM-740	09-029A-7400	KRT12-5BF	11					
KM-740BL	09-029A-740L	KRT12-5LM	13					
KM-750	07-053A-7500/CHK-HA002700	KRT12-5BF	11					
KM-750-7	07-051A-7507/CHK-HA002600	KRT842CI	11					
KM-750BL	07-054A-750L/CHK-HA003000	KRT872L	13					
KM-790	07-055A-7900/ CHK-HA002900	SKRT845BK with Cap	12	KRT845BK hook only	12		SCP-842BK	23
KM-790-7	07-056A-7907/ CHK-HA002800	SKRT845KC with Cap	12	KRT842KC hook only	12	07-063A-7900	SCP-842BKC	23
KM-790BL	07-052A-790L/ CHK-HA003100	SKRT875LK with Cap		KRT875LK hook only		07-064A-790L	SCP-LBK	
KM-790BL-7	07-052A-75L7/ CHK-HA001000	SKRT875LKC with Cap	14	KRT875LC hook only	14	07-001A-5607	SCP-LBKC	23
KM-815C/-825C/-857/-867	09-036A-8570/CHK-HA004400	KRT31-R	15					
KM-857-7/-867-7	09-031A-8577/ CHK-HA001800	SKRT470C-R with Cap	16	KRT470C-R hook only	16		SCPF441	23
KM-957/-967	09-070A-9570	SKRT470-R with Cap	16	KRT470-R hook only	16		SCPF15	23

Teflon 特氟隆内釜

DLC 像鑽石一樣堅硬的石炭塗層内釜

Ti 鈦塗層

ADJ 护针片調整旋梭

N 附防止空轉彈簧片

* = EXCLUSIVE ITEMS

SUNSTAR(日星)

MACHINE (机器)	HOOK (旋梭)					BOBBIN CASE & CAP (梭壳 & 梭帽)		
	PART NO. (配件型号)	KOBAN NO.1 (佐文型号1)	PAGE	KOBAN NO.2 (佐文型号2)	PAGE	PART NO. (配件型号)	KOBAN NO. (佐文型号)	PAGE
KM-957-7/-967-7	09-031A-8577/ CHK-HA001800	SKRT470C-R with Cap	16	KRT470C-R hook only	16		SCPF441	23
KM-1750/1751	07-051A-7507/CHK-HA002600	KRT842CI	11					
KM-1750BL	07-052A-790L/ CHK-HA003100	SKRT875LK with Cap		KRT875LK hook only		07-064A-790L	SCP-LBK	
KM-1790/-1791	07-056A-7907/ CHK-HA002800	SKRT845KC with Cap	12	KRT842KC hook only	12	07-063A-7900	SCP-842BKC	23
KM-1790BL	07-052A-75L7/ CHK-HA001000	SKRT875LKC with Cap	14	KRT875LC hook only	14	07-001A-5607	SCP-LBKC	23
KM-2070/-2070P	07-001A-2070	KRP457JTI Ti	10	KRP457JICC DLC	10	07-002A-2070	SC70-3JNS N	27
KM-2077	07-001A-2077/ CHK-HA000600	KRP856TI Ti	10	KRP856ICC DLC		07-002A-2077	SC70-3WFLNS N	27
KM-2300S(M)-A/G	07-003A-270A/CHK-HA000700	KHS12-SPD2	3			07-106A-2700	SC31-NS N	24
KM-2300S(M)-B	07-003A-270B/CHK-HA000900	KHS12-GTHPD	1			07-004A-3500	SC82-JNS N	25
KM-2301B	07-003A-270B/CHK-HA000900	KHS12-GTHPD	1					
KM-2310G	07-003A-270A/CHK-HA000700	KHS12-SPD2	3			07-106A-2700	SC31-NS N	24
SJS/A-PS/A	GP-000814-00/CHK-HA000400	KHS20-RMP	4			GP-012152-00	SC33-LNS N	26
SPS/A-1306G/1507G	07S029S-306G/ CHK-HA000100	SH181K				07S023S-306H/ CHK-HC000100	SC181SU N	
SPS/A-1306H/1507H	07S028S-306H/ CHK-HA001600	SH181KH						
SPS/A-1811H/2211G	07S029S-306G/ CHK-HA000100	SH181K						
SPS/A-1811H/2211H	07S028S-306H/ CHK-HA001600	SH181KH						
SPS/A-3020G/ 5030G/7030G	07S029S-306G/ CHK-HA000100	SH181K						
SPS/A-3020H/ 5030H/7030H	07S028S-306H/ CHK-HA001600	SH181KH						
SPS/A(B)-2516G	07S029S-306G/ CHK-HA000100	SH181K						
SPS/A(B)-2516H	07S028S-306H/ CHK-HA001600	SH181KH						
SPS/C-B1201H	07-128A-120H/CHK-HA000200	SH282	21			07-023A-120H	SC980N	29
SPS/C-B1201K/L/M	07-129A-120M/CHK-HA000300	SH280	21					
SPS/C-5050/8050	GP-000814-00/CHK-HA000400	KHS20-RMP	4			GP-012152-00	SC33-LNS N	26
SPS/C(D)-B1202	07-129A-120M/CHK-HA000300	SH280	21			07-023A-120H	SC980N	29
SPS/D-B1254/1263H	07-128A-120H/CHK-HA000200	SH282	21					
SPS/D-B1254/1263M	07-129A-120M/CHK-HA000300	SH280	21					
SPS/E-1306G/1507G	07S029S-306G/ CHK-HA000100	SH181K				07S023S-306H/ CHK-HC000100	SC181SU N	
SPS/E-1306H/1507H	07S028S-306H/ CHK-HA001600	SH181KH						
SPS/E-5050/8050	GP-000814-00/CHK-HA000400	KHS20-RMP	4			GP-012152-00	SC33-LNS N	26
SPS/E-BS-1202	07-129A-120M/CHK-HA000300	SH280	21			07-023A-120H	SC980N	29
SPS/F-2516G/3020G	07S029S-306G/ CHK-HA000100	SH181K				07S023S-306H/ CHK-HC000100	SC181SU N	
SPS/F-2516H/3020H	07S028S-306H/ CHK-HA001600	SH181KH						
SPS/N-2516G/3020G	07S029S-306G/ CHK-HA000100	SH181K						

Teflon HOOK BASE TEFLON

DLC HOOK BASE DLC COATING
MINIMAL OIL

Ti HOOK BASE
TITANIUM COATING

ADJ ADJUSTABLE STRONG
NEEDLE GUARD

N WITH NON SLIP SPRING

* = EXCLUSIVE ITEMS

SUNSTAR(日星)								
MACHINE (機器)	HOOK (旋梭)					BOBBIN CASE & CAP (梭壳 & 梭帽)		
	PART NO. (配件型号)	KOBAN NO.1 (佐文型号1)	PAGE	KOBAN NO.2 (佐文型号2)	PAGE	PART NO. (配件型号)	KOBAN NO. (佐文型号)	PAGE
SPS/N-2516H/3020H	07S028S-306H/ CHK-HA001600	SH181KH				07S023S-306H/ CHK-HC000100	SC181SU N	
SPS/S-CV2	GP-000814-00/CHK-HA000400	KHS20-RMP	4			GP-012152-00	SC33-LNS N	26

TAJIMA(田島)								
MACHINE (機器)	HOOK (旋梭)					BOBBIN CASE & CAP (梭壳 & 梭帽)		
	PART NO. (配件型号)	KOBAN NO.1 (佐文型号1)	PAGE	KOBAN NO.2 (佐文型号2)	PAGE	PART NO. (配件型号)	KOBAN NO. (佐文型号)	PAGE
TEJT TFGN TFGN-C TFJT-C TFKN TFMX TFMX- II TFMX- II C TFMX-C TMCE TMLH	050210170019* 050210190018* 050230060013* 05022007J014* 05022010J002* 05022005J015*	KHS12-RYPT2* KHS12-RYPOET2* KHS12-RBPT2* KHS20-RYPT2* KHS20-RYPNT2* Teflon KHS20-RYPOET2*		KHS12-RYP KHS12-RYPOE0J2 KHS12-RBP KHS20-RYP KHS20-RYPN Teflon	1 2 5 5		SC35-NS N SC34-2NS N SC35-LNS N	24 24 26

TAKING(天王星)								
MACHINE (機器)	HOOK (旋梭)					BOBBIN CASE & CAP (梭壳 & 梭帽)		
	PART NO. (配件型号)	KOBAN NO.1 (佐文型号1)	PAGE	KOBAN NO.2 (佐文型号2)	PAGE	PART NO. (配件型号)	KOBAN NO. (佐文型号)	PAGE
TK-86		KRT11-5LJS	13					
TK-89		KHS12-S	2					
TK-89H		KHS12-R	1				SC31	24
TK-8BL		KHS20-RPEM2AO	5				SC33-LD N	26
TK-243		KSP204N	18					
TK-335/-335N		KR24-B	8				SC34-1	24
TK-335LB/-335NLB		KHS20-R	4				SC33-L	26
TK-341/-341N		SKRT341G with Cap	20	KRT341G hook only	20		SCP545	23
TK-441/-471		KSP204N	18					
TK-457A/-457U		KRP457-W	10				SC70-3	27
TK-545/-546		SKRT545 with Cap		KRT545 hook only				
TK-551		SKRT545G with Cap	20	KRT545G hook only	20		SCP545	23
TK-591/-591B/-591BF		SKRT470-R with Cap	16	KRT470-R hook only	16			
TK-592/-592B/-592BF		SKRT470-R with Cap	16	KRT470-R hook only	16		SCPF15	23
TK-652		KR24-B	8				SC34-1	24
TK-691/-691B/-691BF		SKRT470-R with Cap	16	KRT470-R hook only	16		SCPF15	23
TK-691T/-691TB/ -692T/-692TB		SKRT470C-R with Cap	16	KRT470C-R hook only	16		SCPF441	23
TK-692/-692B/ -692BF		SKRT470-R with Cap	16	KRT470-R hook only	16		SCPF15	23
TK-591T/-591TB/ -592T/-592TB		SKRT470C-R with Cap	16	KRT470C-R hook only	16		SCPF441	23
TK-735/-735N		KR238	8				SC39	24
TK-810		KRT31-R	15					
TK-820		KRT31-NR	15					

Teflon 特氟隆内釜

DLC 像鑽石一樣堅硬的石炭塗層内釜

Ti 鈦塗層

ADJ 护针片調整旋梭

N 附防止空軋彈簧片

* = EXCLUSIVE ITEMS

TAKING (天王星)

MACHINE (机器)	HOOK (旋梭)					BOBBIN CASE & CAP (梭壳 & 梭帽)		
	PART NO. (配件型号)	KOBAN NO.1 (佐文型号1)	PAGE	KOBAN NO.2 (佐文型号2)	PAGE	PART NO. (配件型号)	KOBAN NO. (佐文型号)	PAGE
TK-832		KRT12-5M	11					
TK-832-LB5		KRT12-5LM	13					
TK-842-3/-5		KRT12-5M	11					
TK-845-3/-5		SKRT12-5MK with Cap	11	KRT12-5MK hook only	11		SCP-MK	23
TK-872/-3/-5		KRT12-5LM	13					
TK-875-3/-5		SKRT12-5LMK with Cap	14	KRT12-5LMK hook only	14		SCP-LMK	23
TK-888/-888VB		KRP41-LH2	10				SC70-771	27
TK-991/-992		SKRT470-R with Cap	16	KRT470-R hook only	16		SCPF15	23
TK-1245/-1245L/ -1246/-1246L		SKRT1242-R with Cap	19	KRT1242-R hook only	19		SCP545	23
TK-1247SHL/ -1247SHR/-1248HB		SKRT391 with Cap		KRT391 hook only			SCPF15H	23
TK-1800/-1814/-1818/ -1821/-1828/-1836/-1842		SH280	21				SC980N	29
TK-1828H/-1836H/-1842H		SH282	21					
TK-1900		SH280	21					
TK-1900H		SH282	21					

TONY (輝煌)

MACHINE (机器)	HOOK (旋梭)					BOBBIN CASE & CAP (梭壳 & 梭帽)		
	PART NO. (配件型号)	KOBAN NO.1 (佐文型号1)	PAGE	KOBAN NO.2 (佐文型号2)	PAGE	PART NO. (配件型号)	KOBAN NO. (佐文型号)	PAGE
H-130-LHA		KHS12-R	1				SC31	24
H-301/-305		KHS20-TZ	6				SC34-LNS N	26
H-370-LHA		KHS20-R	4				SC33-L	26

TOYOTA (豊田)

MACHINE (机器)	HOOK (旋梭)					BOBBIN CASE & CAP (梭壳 & 梭帽)		
	PART NO. (配件型号)	KOBAN NO.1 (佐文型号1)	PAGE	KOBAN NO.2 (佐文型号2)	PAGE	PART NO. (配件型号)	KOBAN NO. (佐文型号)	PAGE
AD140B/146G/148B	2110904310	KHS12-GTH	1			2110104301C	SC31	24
AD148/148M	2120604310	KHS12-S	2					
AD150G/156G	2110904310	KHS12-GTH	1					
AD156/156M	2120604310	KHS12-S	2					
AD157	2111704310C	KHS12-SPA3				2110604301B	SC31-NS N	24
AD157G-500	2110904310	KHS12-GTH	1			2110104301C	SC31	24
AD320-22	2122304310G	KHS20-SPEM2ANG				2122304301B	SC33-LD N	26
AD331L/331LP	2121414310	KRT-LS2S						
AD332L/332LP	2121414310	KRT-LS2S						
AD338/345/352	2120604310	KHS12-S	2			2110104301C	SC31	24
AD340/340B-622	2121414310C	KHS12-SPD3	2			2121604301B	SC82-JNS N	25
AD340-22/-622	2111704310C	KHS12-SPA3				2110604301B	SC31-NS N	24
AD340B	2121624310B	KHS12-RHPD	1			2121604301B	SC82-JNS N	25
AD340B-22		KHS12-GTHPD	1			2110604301B	SC31-NS N	24
AD341	2121414310C	KHS12-SPD3	2			2121604301B	SC82-JNS N	25
AD345-22/-622	2111704310C	KHS12-SPA3				2110604301B	SC31-NS N	24
AD352-702	2111704310C	KHS12-SPA3						
AD550/551	2130504310	KRP457	10			2130704301A	SC70-3	27

Teflon HOOK BASE TEFLON

DLC HOOK BASE DLC COATING
MINIMAL OIL

Ti HOOK BASE
TITANIUM COATING

ADJ ADJUSTABLE STRONG
NEEDLE GUARD

N WITH NON SLIP SPRING

* = EXCLUSIVE ITEMS

TOYOTA (豊田)

MACHINE (機器)	HOOK (旋梭)					BOBBIN CASE & CAP (梭壳 & 梭帽)		
	PART NO. (配件型号)	KOBAN NO.1 (佐文型号1)	PAGE	KOBAN NO.2 (佐文型号2)	PAGE	PART NO. (配件型号)	KOBAN NO. (佐文型号)	PAGE
AD552/553	2130504310	KRP457	10			2130704301A	SC70-3	27
AD740/740B	2140114310	KRT21	15					
AD830	2161914310	KHS12-RYP	1				SC35-NS N	24
AD851	2161924310	KHS12-RYPICC DLC	2					
AD1000/1012G/1202K/1203V	2111704310C	KHS12-SPA3				2110604301B	SC31-NS N	24
AD2000/3000	2111704310C	KHS12-SPA3						
AD3110/3310/3320	2123704310A	KRT-LS2CI-S	13					
D324	2120304310B	KHS20-S	5			2120304301	SC33-L	26
D530/530E/532	2130104300	KHS20-ST	5			2130104301A	SC34-L	26
D533/534	2130104300	KHS20-ST	5					

TREASURE (珠宝)

MACHINE (機器)	HOOK (旋梭)					BOBBIN CASE & CAP (梭壳 & 梭帽)		
	PART NO. (配件型号)	KOBAN NO.1 (佐文型号1)	PAGE	KOBAN NO.2 (佐文型号2)	PAGE	PART NO. (配件型号)	KOBAN NO. (佐文型号)	PAGE
HS-5500	S60197A	SKRT19-R with Cap		KRT19-R hook only			SCP18	

TTY (大羽)

MACHINE (機器)	HOOK (旋梭)					BOBBIN CASE & CAP (梭壳 & 梭帽)		
	PART NO. (配件型号)	KOBAN NO.1 (佐文型号1)	PAGE	KOBAN NO.2 (佐文型号2)	PAGE	PART NO. (配件型号)	KOBAN NO. (佐文型号)	PAGE
TTY-9618		SKRT592V2-R with Cap ADJ	16	KRT592V2-R hook only ADJ	16		SCPF572	23
TTY-9922		SKRT592V2-R with Cap ADJ	16	KRT592V2-R hook only ADJ	16		SCPF572	23
TTY-91218		SKRT592V2-R with Cap ADJ	16	KRT592V2-R hook only ADJ	16		SCPF572	23

TYPICAL (標準)

MACHINE (機器)	HOOK (旋梭)					BOBBIN CASE & CAP (梭壳 & 梭帽)		
	PART NO. (配件型号)	KOBAN NO.1 (佐文型号1)	PAGE	KOBAN NO.2 (佐文型号2)	PAGE	PART NO. (配件型号)	KOBAN NO. (佐文型号)	PAGE
GC6-1		KHS12-S	2				SC31	24
GC6-1-D3		KHS12-SPD2	3				SC31-NS N	24
GC6-5/-6/-7		KHS20-RMP	4				SC33-LNS N	26
GC6-8		KHS12-R	1				SC31	24
GC6-8A/-8B		KHS12-GTH	1					
GC6-8-D2		KHS12-GTHPD	1				SC31-NS N	24
GC6-9		KHS20-RM2	4				SC33-L	26
GC6-9-D2		KHS20-RMP	4				SC33-LB N	26
GC6-10/-11		KHS12-SD	2				SC82-J	25
GC6-28		KHS12-S	2				SC31	24
GC38-1/-2		KHS12-S	2					

Teflon 特氟隆内釜

DLC 像鑽石一樣堅硬的石炭塗層内釜

Ti 鈦塗層

ADJ 护针片調整旋梭

N 附防止空轉彈簧片

* = EXCLUSIVE ITEMS

TYPICAL (標準)

MACHINE (機器)	HOOK (旋梭)					BOBBIN CASE & CAP (梭壳 & 梭帽)		
	PART NO. (配件型号)	KOBAN NO.1 (佐文型号1)	PAGE	KOBAN NO.2 (佐文型号2)	PAGE	PART NO. (配件型号)	KOBAN NO. (佐文型号)	PAGE
GC40-1/-2/-4		KHS12-S	2					
GC69-1		KHS12-S	2				SC31	24
GC6100HD		KHS12-SB3OHO	2					
GC6150M/6150H		KHS12-R	1				SC31-NS N	24
GC6160		KHS12-SD	2				SC82-J	25
GC6160H		KHS12-SPB3OHO	2				SC31	24
GC6180		KHS20-RM2	4				SC33-L	26
GC6220B		KRT12-5LM	13					
GC6220BD		KRT12-5LMKCI	13					
GC6220M		KRT12-5M	11					
GC6220MD		KRT12-5MCI						
GC6240B		SKRT12-5LMK with Cap	14	KRT12-5LMK hook only	14		SCP-LMK	23
GC6240M		SKRT12-5MK with Cap	11	KRT12-5MK hook only	11		SCP-MK	23
GC6240MD		SKRT12-5MC-2 with Cap		KRT12-5MC hook only			SCP-MKC	
GC6240MD2		SKRT12-5MC-1 with Cap		KRT12-5MC hook only			SCP-MC	
GC6710M/6710HD3		KHS12-SP					SC31-NS N	24
GC6720HD3		KHS12-SPB3OHO	2				SC31	24
GC6730HD3		KHS12-SPB3OHO	2					
GC6730MD3		KHS12-SPD2	3				SC31-NS N	24
GC6842H		KRT842H-S	11					
GC6842HD3/6842MD3		SKRT842C with Cap	11	KRT842KC hook only	11		SCP-842BC	23
GC6842M		KRT842F-S	11		11			
GC6845/H		SKRT845BK with Cap	12	KRT845BK hook only	12		SCP-842BK	23
GC6845HD3/6845MD3		SKRT845KC with Cap	12	KRT842KC hook only	12		SCP-842BKC	23
GC6872/6872H/6872M		KRT872L	13					
GC6872MD3		SKRT872LC with Cap	14	KRT875LC hook only	14		SCP-LBC	23
GC6875H/6875M		SKRT875LK with Cap		KRT875LK hook only			SCP-LBK	
GC6875HD3/6875MD3		SKRT875LKC with Cap	14	KRT875LC hook only	14		SCP-LBKC	23
GC9420H		KRT842H-S	11					
GC9420M		KRT842F-S	11					
GC9420M/9420HD3		SKRT842C with Cap	11	KRT842KC hook only	11		SCP-842BC	23
GC9450		SKRT845BK with Cap	12	KRT845BK hook only	12		SCP-842BK	23
GC9450M/9450HD3		SKRT845KC with Cap	12	KRT842KC hook only	12		SCP-842BKC	23
GC9720		KRT872L	13					
GC9720M/9720HD3		SKRT872LC with Cap	14	KRT875LC hook only	14		SCP-LBC	23
GC9750		SKRT875LK with Cap		KRT875LK hook only			SCP-LBK	

Teflon HOOK BASE TEFLON

DLC HOOK BASE DLC COATING
MINIMAL OIL

Ti HOOK BASE
TITANIUM COATING

ADJ ADJUSTABLE STRONG
NEEDLE GUARD

N WITH NON SLIP SPRING

* = EXCLUSIVE ITEMS

TYPICAL (標準)								
MACHINE (機器)	HOOK (旋梭)					BOBBIN CASE & CAP (梭壳 & 梭帽)		
	PART NO. (配件型号)	KOBAN NO.1 (佐文型号1)	PAGE	KOBAN NO.2 (佐文型号2)	PAGE	PART NO. (配件型号)	KOBAN NO. (佐文型号)	PAGE
GC9750M/9750HD3		SKRT875LKC with Cap	14	KRT875LC hook only	14		SCP-LBKC	23
GC20201		KRT12-5M	11					
GC20201-1		KRT12-5MR						
GC20202		KRT12-5LM	13					
GC20202-1		KRT12-5LMR						
GC20665		KRT11-5LJR	13					
GC20665-D2T3		KRT150LJC2ICC-R DLC						
GC24080		KRT31-NR	15					
GC24690		KRT8-LPR	19					
GG1-1/-2		KR24	8				SC35	24
GN2301		KHS20-RMP	4				SC33-LNS N	26
GN2603		KHS20-RMP	4					
GYD12-6		KHS12-RY	1				SC35-NS N	24
GYD20-6		KHS12-RY	1					
GYD7-6		KHS12-RY	1					
TW1-28BL		KRT14-5-O	17					
TW1-2B		KRT132	17					

TYPICAL WANPING (菟坪)								
MACHINE (機器)	HOOK (旋梭)					BOBBIN CASE & CAP (梭壳 & 梭帽)		
	PART NO. (配件型号)	KOBAN NO.1 (佐文型号1)	PAGE	KOBAN NO.2 (佐文型号2)	PAGE	PART NO. (配件型号)	KOBAN NO. (佐文型号)	PAGE
733R		KSP7-31	18					
842		KRT12-5BFCI						
845		SKRT845KC with Cap	12	KRT842KC hook only	12		SCP-842BKC	23
872		SKRT872LC with Cap	14	KRT875LC hook only	14		SCP-LBC	23
875		SKRT875LKC with Cap	14	KRT875LC hook only	14		SCP-LBKC	23
1245		SKRT1242-R with Cap	19	KRT1242-R hook only	19		SCP545	23
B727		KHS20-GTB	4				SC33-L	26
GC0302		KHS20-GTB	4					
GC0302-D2		KHS20-SMP	5				SC33-LNS N	26
GC203		KHS12-S	2	KHS12-R	1		SC31	24
GC20606		KRT12-5LM	13					
GC20665		KRT11-5LJS	13					
GC24016		KRT31-NR	15					
GC24026		KRT31-SG						
GC24080		KRT31-NR	15					
GC24660		SKRT470-S with Cap		KRT470-S hook only			SCPF15	23
GC24680		SKRT470-S with Cap		KRT470-S hook only				
GC3002CX		KHS20-RPE	5				SC33-LD N	26
GC6-5/-6/-7		KHS20-RMP	4				SC33-LNS N	26
GN2301		KHS20-RMP	4					

Teflon 特氟隆内釜

DLC 像鑽石一樣堅硬的石炭塗層内釜

Ti 鈦塗層

ADJ 护针片調整旋梭

N 附防止空轉彈簧片

* = EXCLUSIVE ITEMS

TYPICAL WANPING (莞坪)

MACHINE (机器)	HOOK (旋梭)					BOBBIN CASE & CAP (梭壳 & 梭帽)		
	PART NO. (配件型号)	KOBAN NO.1 (佐文型号1)	PAGE	KOBAN NO.2 (佐文型号2)	PAGE	PART NO. (配件型号)	KOBAN NO. (佐文型号)	PAGE
GN2603		KHS20-RMP	4				SC33-LNS N	26
PWB-8GW		SKRT470-R with Cap	16	KRT470-R hook only	16		SCPF15	23
SK-2B		KRT132	17					
TW1-0602		KHS20-RPEM2AO	5				SC33-LD N	26
TW1-1245		SKRT1242-R with Cap	19	KRT1242-R hook only	19		SCP545	23
TW2-B842/-B843		KRT842F-S	11					
TW2-B842-905		KRT842CI	11					
TW2-B845/-B845-5		SKRT845BK with Cap	12	KRT845BK hook only	12		SCP-842BK	23
TW2-B845-905		SKRT845KC with Cap	12	KRT842KC hook only	12		SCP-842BKC	23
TW2-B872		KRT872L	13					
TW2-B872-905		SKRT872LC with Cap	14	KRT875LC hook only	14		SCP-LBC	23
TW2-B875		SKRT875LK with Cap		KRT875LK hook only			SCP-LBK	
TW2-B875-905		SKRT875LKC with Cap	14	KRT875LC hook only	14		SCP-LBKC	23
TW3-243		KSP204N	18					
TW3-335/-335V		KR69-V	9				SC39-14	24
TW3-341		SKRT341-NR with Cap	20	KRT341-NR hook only	20		SCP545	23
TW3-441/-471		KSP204N	18					
TW3-8B		KRT31-11S	15					
TW3-P335		KR238	8				SC39-14	24
TW3-S336VB		KHS20-GTVG	4				SC33-LNS3 N	26
TW5-810		KRT31-NR	15					
TW5-820		KRT31-SG						
TWB-22GW		SKRT470-R with Cap	16	KRT470-R hook only	16		SCPF15	23

UNICORN (神馬)

MACHINE (机器)	HOOK (旋梭)					BOBBIN CASE & CAP (梭壳 & 梭帽)		
	PART NO. (配件型号)	KOBAN NO.1 (佐文型号1)	PAGE	KOBAN NO.2 (佐文型号2)	PAGE	PART NO. (配件型号)	KOBAN NO. (佐文型号)	PAGE
DB2-H310/-H510/-H515		KHS12-S	2				SC31	24
DB2-H311/-H510H/-H515H		KHS12-R	1					
DB2-H312/-H510XH/-H515XH		KHS20-RM2	4				SC33-L	26
DB2-H320/-H321		KRT12-5M	11					
DB2-H322/-H323		KRT12-5LM	13					
DY-H340		KHS20-RM2	4				SC33-L	26
LS2-H455/-H800		KHS12-SPD2	3					
LS2-H5100(M)/-H5150M		KHS12-SPD2	3				SC31-NS N	24
LS2-H5100H/-H5150H		KHS12-GTHPD	1					
LS2-H5150XH/-H5110XH		KHS20-RMP	4				SC33-LNS N	26
LS2-H520		KHS12-SD	2				SC31	24
LS2-H5200/-H5300/ -H5500/-H6000-D		KHS12-SPD2	3				SC31-NS N	24
LS2-H530		KHS12-SB2	2				SC31	24
LS2-H540/-H5400/-H5100XH		KHS20-RMP	4				SC33-LNS N	26

Teflon HOOK BASE TEFLON

DLC HOOK BASE DLC COATING
MINIMAL OIL

Ti HOOK BASE
TITANIUM COATING

ADJ ADJUSTABLE STRONG
NEEDLE GUARD

N WITH NON SLIP SPRING

* = EXCLUSIVE ITEMS

UNICORN(神馬)								
MACHINE (機器)	HOOK (旋梭)					BOBBIN CASE & CAP (梭壳 & 梭帽)		
	PART NO. (配件型号)	KOBAN NO.1 (佐文型号1)	PAGE	KOBAN NO.2 (佐文型号2)	PAGE	PART NO. (配件型号)	KOBAN NO. (佐文型号)	PAGE
LS2-H550		KHS12-S	2				SC31	24
LS2-H620(H)		KRT12-5LM	13					
LS2-H620/-H620(M)		KRT12-5M	11					
LT2-H6200(H)		KRT12-5LMKCI	13					
LT2-H6200(M)		KRT12-5MCI						
LT2-H625(H)		SKRT12-5LMK with Cap	14	KRT12-5LMK hook only	14		SCP-LMK	23
LT2-H625(M)		SKRT12-5MK with Cap	11	KRT12-5MK hook only	11		SCP-MK	23
LT2-H6250(M)		SKRT12-5MC-1 with Cap		KRT12-5MC hook only			SCP-MC	
LT2-H6500		KRT12-5LMKC-CI	13					
LT5-H710/-H720		KRT31-SG						
LT5-H7200/-H7600		SKRT470C-R with Cap	16	KRT470C-R hook only	16		SCPF441	23
LZ2-H272		KR24	8				SC35	24
PLN-7B/-27B		KRT31-SG						
TZ1-B652		KR24-B	8				SC35	24
TZ-H2100		KRP457JTI Ti	10	KRP457JICC DLC	10		SC70-3JNS N	27
UAS-H1407(H)		SH181H	21				SC181H N	28
UAS-H1407(M)		SH181	21				SC181 N	28
UAS-H900/-H903-DF		SH280	21				SC980N	29

UNION SPECIAL (於仁)								
MACHINE (機器)	HOOK (旋梭)					BOBBIN CASE & CAP (梭壳 & 梭帽)		
	PART NO. (配件型号)	KOBAN NO.1 (佐文型号1)	PAGE	KOBAN NO.2 (佐文型号2)	PAGE	PART NO. (配件型号)	KOBAN NO. (佐文型号)	PAGE
61200	61207D	KR62					SC31	24
61200, 61400, 61900, 63400, 63900	61407B	KHS14-G				61413	SC83	
	61407BFG	KHS14-S						
	61407BSN	KHS14-SS				63913A	SC639	
	61407BTS	KHS14-GN Teflon						
61800, 62200	29474AC	KRT22						

YAKUMO (八云)								
MACHINE (機器)	HOOK (旋梭)					BOBBIN CASE & CAP (梭壳 & 梭帽)		
	PART NO. (配件型号)	KOBAN NO.1 (佐文型号1)	PAGE	KOBAN NO.2 (佐文型号2)	PAGE	PART NO. (配件型号)	KOBAN NO. (佐文型号)	PAGE
171L	B1830141HA0	KHS20-RM3	4			201144000	SC33-L	26
178Y-2	112034010	KHS12-SP				112035000	SC31-NS N	24
180LY-2/181LY	D1830141EA0	KHS20-RMPN	4			D1837141EA0	SC33-LNS3 N	26
241L	117074005	KRT11-5LJR	13					
242L	B1830521HA0	KRT11-5LJKR				B18375210A0	SCP-LJ	
242L	B1830521HA0	KRT11-5LJKR				B18375260A0	SCP-LJK	
243	21041850	KSP204N	18					

Teflon 特氟隆内釜

DLC 像鑽石一樣堅硬的石炭塗層内釜

Ti 鈦塗層

ADJ 护针片調整旋梭

N 附防止空軋彈簧片

* = EXCLUSIVE ITEMS

YAKUMO (八云)

MACHINE (机器)	HOOK (旋梭)					BOBBIN CASE & CAP (梭壳 & 梭帽)		
	PART NO. (配件型号)	KOBAN NO.1 (佐文型号1)	PAGE	KOBAN NO.2 (佐文型号2)	PAGE	PART NO. (配件型号)	KOBAN NO. (佐文型号)	PAGE
280L	110017000	KHS20-HPEW	4			B1837241H00	SC33-LD N	26
280LY	D1830141EA0	KHS20-RMPN	4			D1837141EA0	SC33-LNS3 N	26
281LY/LY-B	D1830241EA0	KHS20-RMPNW	4					
321L	21228051	SKRT341G with Cap	20	KRT341G hook only	20	115470005	SCP545	23
340	B18013400A0	KRT31-11SG	15					
341	B18303110A0	KRT341GI						
341L	21228051	SKRT341G with Cap	20	KRT341G hook only	20	115470005	SCP545	23
380/380B/380Y	109068010	KR21-RPDE	8			109471005	SC81-2NS2 N	24
380/380B/380Y	109068030	KR21-GTPDE	8					
381L	110017000	KHS20-HPEW	4			B1837241H00	SC33-LD N	26
381LY	D1830141EA0	KHS20-RMPN	4			D1837141EA0	SC33-LNS3 N	26
411~471	21041850	KSP204N	18					
480L	111066110	KRT12-5LJR						
481L/482L	222098000	KRT11-5LJR	13					
561~564	116728000	SKRT470-S with Cap		KRT470-S hook only			SCPF15	23
580L	B1830141HA0	KHS20-RM3	4			201144000	SC33-L	26
680LY	D1830141EA0	KHS20-RMPN	4			D1837141EA0	SC33-LNS3 N	26
681	21209051	KHS12-RPN2D2	1			109471005	SC81-2NS2 N	24
681	21209952	KHS12-GTPN2D2	1					
681LY-B	D1830141EA0	KHS20-RMPN	4			D1837141EA0	SC33-LNS3 N	26
880LM	110017000	KHS20-HPEW	4			B1837241H00	SC33-LD N	26
981~986	21010251	KRT31-NR	15					
DBE-780/-N63	103109020	KR21-S	8			203072000	SC31	24
DBU-175	103109020	KR21-S	8					
DBU-175L	B1830141HA0	KHS20-RM3	4			201144000	SC33-L	26
DBU-180	103109020	KR21-S	8			203072000	SC31	24
DBU-180-2	103109010	KR21-R	8					
DBU-180L-2	B1830141HA0	KHS20-RM3	4			201144000	SC33-L	26
DBU-181LY/-681LY	D1830141EA0	KHS20-RMPN	4			D1837141EA0	SC33-LNS3 N	26
DEU-750/-780/-N70	103109020	KR21-S	8			203072000	SC31	24
DNU-241H	D1830241EA0	KHS20-RMPNW	4			D1837141EA0	SC33-LNS3 N	26
DSC-245	B18302450A0	KHS12-GTPND2	1			B18372450A0	SC82-JNS2 N	25
DSC-246	110017000	KHS20-HPEW	4			B1837241H00	SC33-LD N	26
DSN-165/-170/-178	104114020	KHS12-S	2			203072000	SC31	24
DSN-178-3	104114010	KHS12-R	1					
DSN-178L-2	104507000	KHS20-S	5			D1837141EA0	SC33-LNS3 N	26
DSN-178L-3	D1830141HA0	KHS20-RM3	4			201144000	SC33-L	26
DSN-78/-80-2	103109020	KR21-S	8			203072000	SC31	24
DSN-80-3	103109010	KR21-R	8					
DSN-80L	B1830141HA0	KHS20-RM3	4			D1837141EA0	SC33-LNS3 N	26
DU141H	B1830141HA0	KHS20-RM3	4					
DU-141H-5/-6/-7	D1830141EA0	KHS20-RMPN	4					
PLN-985	21010251	KRT31-NR	15					

YAMATO (大和)

MACHINE (机器)	HOOK (旋梭)					BOBBIN CASE & CAP (梭壳 & 梭帽)		
	PART NO. (配件型号)	KOBAN NO.1 (佐文型号1)	PAGE	KOBAN NO.2 (佐文型号2)	PAGE	PART NO. (配件型号)	KOBAN NO. (佐文型号)	PAGE
DP-2/-3		KRP41-S	10				SC70-2	27

Teflon HOOK BASE TEFLON

DLC HOOK BASE DLC COATING
MINIMAL OIL

Ti HOOK BASE
TITANIUM COATING

ADJ ADJUSTABLE STRONG
NEEDLE GUARD

N WITH NON SLIP SPRING

* = EXCLUSIVE ITEMS

YAMATO (大和)								
MACHINE (機器)	HOOK (旋梭)					BOBBIN CASE & CAP (梭壳 & 梭帽)		
	PART NO. (配件型号)	KOBAN NO.1 (佐文型号1)	PAGE	KOBAN NO.2 (佐文型号2)	PAGE	PART NO. (配件型号)	KOBAN NO. (佐文型号)	PAGE
LG2000 2105-LW/MW 2125-LW/MW 2135-LW/MW 2205-LW 2225-LW 2235-LW LG2347-LW-T30/SC50		KRP457-W3					SC70-3NS N	

YULUN (友倫)								
MACHINE (機器)	HOOK (旋梭)					BOBBIN CASE & CAP (梭壳 & 梭帽)		
	PART NO. (配件型号)	KOBAN NO.1 (佐文型号1)	PAGE	KOBAN NO.2 (佐文型号2)	PAGE	PART NO. (配件型号)	KOBAN NO. (佐文型号)	PAGE
457A-105L/-125L/-135L/-140L		KRP457-W	10				SC70-3	27
475A-143NL		KRP457JTI Ti	10	KRP457JICC DLC	10		SC70-3JNS N	27
457A-505-PBG-NHL, 457A-525-PBG-NHL		KRP457	10				SC70-3	27
457A-535-PBG-NHL, 457A-543-PBG-NHL		KRP457JTI Ti	10	KRP457JICC DLC	10		SC70-3JNS N	27
457A-605-NCB-LG, 457A-625-NCB-LG		KRP457	10				SC70-3	27
457A-635-NCB-LG, 457A-643-NCB-LG		KRP457JTI Ti	10	KRP457JICC DLC	10		SC70-3JNS N	27
YLM-1245/-1246		SKRT1242-R with Cap	19	KRT1242-R hook only	19		SCP545	23
YLM-335		KR24-B	8				SC35	24
YLM-340/-350-22		KHS20-R	4				SC33-L	26
YLM-457A		KRP457-W	10				SC70-3	27
YLM-545/-546		SKRT1242-R with Cap	19	KRT1242-R hook only	19		SCP545	23
YLM-572W/-671W		SKRT470-R with Cap	16	KRT470-R hook only	16		SCPF15	23
YLM-810-G/-820-G		KRT31-R	15					

YXSM (裕祥)								
MACHINE (機器)	HOOK (旋梭)					BOBBIN CASE & CAP (梭壳 & 梭帽)		
	PART NO. (配件型号)	KOBAN NO.1 (佐文型号1)	PAGE	KOBAN NO.2 (佐文型号2)	PAGE	PART NO. (配件型号)	KOBAN NO. (佐文型号)	PAGE
YU-1850-M		SH280	21				SC980N	29
YU-1850-XL		SH280	21					

ZGM (珠光)								
MACHINE (機器)	HOOK (旋梭)					BOBBIN CASE & CAP (梭壳 & 梭帽)		
	PART NO. (配件型号)	KOBAN NO.1 (佐文型号1)	PAGE	KOBAN NO.2 (佐文型号2)	PAGE	PART NO. (配件型号)	KOBAN NO. (佐文型号)	PAGE
GG798-1		KHS12-RYP	1				SC35-NS N	24
GG798-3		KHS12-R	1				SC31	24

Teflon 特氟隆内釜

DLC 像鑽石一樣堅硬的石炭塗層内釜

Ti 鈦塗層

ADJ 护针片調整旋梭

N 附防止空轉彈簧片

* = EXCLUSIVE ITEMS

ZOJE (中捷)

MACHINE (机器)	HOOK (旋梭)					BOBBIN CASE & CAP (梭壳 & 梭帽)		
	PART NO. (配件型号)	KOBAN NO.1 (佐文型号1)	PAGE	KOBAN NO.2 (佐文型号2)	PAGE	PART NO. (配件型号)	KOBAN NO. (佐文型号)	PAGE
845		SKRT845BK with Cap	12	KRT845BK hook only	12		SCP-842BK	23
872		KRT872L	13					
875		SKRT875LK with Cap		KRT875LK hook only			SCP-LBK	
1163		KHS12-S	2				SC31	24
1163-5		KHS12-R	1					
842-5		KRT842H-S	11					
842-D3		KRT12-5BFCI						
845-D3		SKRT845KC with Cap	12	KRT842KC hook only	12		SCP-842BKC	23
872-D3		SKRT872LC with Cap	14	KRT875LC hook only	14		SCP-LBC	23
875-D3		SKRT875LKC with Cap	14	KRT875LC hook only	14		SCP-LBKC	23
GC15-1		KHS12-2S	1					
GC5580		KHS12-2S	1					
GC5580-5		KHS12-R	1					
GC80-1		KHS12-2S	1				SC31	24
GC80-5		KHS12-GTH	1					
GC90-1		KHS12-2S	1					
GC90-5		KHS12-GTH	1					
GCZ201-1		KHS12-2S	1					
GG20U142/143/23/33/42/53/63		KR24U-42	9				SC35	24
GG457		KRP457	10				SC70-3	27
ZJ15-1		KHS12-2S	1				SC31	24
ZJ1900		SH280	21					
ZJ1900HS		SH282	21				SC980N	29
ZJ1903/-303/-304/-305		SH280	21					
ZJ201-1		KHS12-S	2				SC31	24
ZJ20U23/33/43/53/63		KR24U-42	9				SC35	24
ZJ2290/2293		KRP457JTI Ti	10	KRP457JICC DLC	10		SC70-3JNS N	27
ZJ2628		KHS12-GTPND2	1				SC82-JNS N	25
ZJ457A/457B/457D		KRP457	10				SC70-3	27
ZJ457A125/105/135/143		KRP457	10					
ZJ5550/5580		KHS12-2S	1				SC31	24
ZJ5580-5		KHS12-GTH	1	KHS12-R	1			
ZJ5580-5-D3, ZJ5580-D3		KHS12-SPD2	3				SC31-NS N	24
ZJ5600N		KHS12-GTH	1				SC31	24
ZJ5780BS, ZJ5781DS		KRP41-LH3ICC DLC	10				SC70-LH3NS N	27
ZJ80-1		KHS12-2S	1				SC31	24
ZJ842		KRT842F-S	11					
ZJ842-5		KRT842H-S	11					
ZJ845/-5		SKRT845BK with Cap	12	KRT845BK hook only	12		SCP-842BK	23
ZJ8500-5		KHS12-GTH	1	KHS12-R			SC31	24
ZJ8500-D3		KHS12-SPD2	3				SC31-NS N	24
ZJ8500H		KHS20-RM2	4				SC33-L	26
ZJ8500N		KHS12-2S	1				SC31	24
ZJ8600/8700		KHS12-S	2					

Teflon HOOK BASE TEFLON

DLC HOOK BASE DLC COATING
MINIMAL OIL

Ti HOOK BASE
TITANIUM COATING

ADJ ADJUSTABLE STRONG
NEEDLE GUARD

N WITH NON SLIP SPRING

* = EXCLUSIVE ITEMS

ZOJE (中捷)								
MACHINE (机器)	HOOK (旋梭)					BOBBIN CASE & CAP (梭壳 & 梭帽)		
	PART NO. (配件型号)	KOBAN NO.1 (佐文型号1)	PAGE	KOBAN NO.2 (佐文型号2)	PAGE	PART NO. (配件型号)	KOBAN NO. (佐文型号)	PAGE
ZJ872/-5		KRT872L	13					
ZJ875/-5		SKRT875LK with Cap		KRT875LK hook only			SCP-LBK	
ZJ8800		KHS12-S	2				SC31	24
ZJ8800-5		KHS12-R	1				SC31	24
ZJ8850-5-D3		KHS12-SPD2	3				SC31-NS N	24
ZJ90-1		KHS12-2S	1				SC31	24
ZJ9503/9600		KHS12-S	2				SC31	24
ZJ9610/9620		SKRT592V2-R with Cap ADJ	16	KRT592V2-R hook only ADJ	16		SCPF572	23
ZJ999		KHS12-2S	1				SC31	24

ZSK								
MACHINE (机器)	HOOK (旋梭)					BOBBIN CASE & CAP (梭壳 & 梭帽)		
	PART NO. (配件型号)	KOBAN NO.1 (佐文型号1)	PAGE	KOBAN NO.2 (佐文型号2)	PAGE	PART NO. (配件型号)	KOBAN NO. (佐文型号)	PAGE
J SERIES L SERIES M SERIES T SERIES X SERIES	573036 573203	KR134Z KR134ZVICC DLC KR134ZICC DLC				570583 570649	SC39-ZSKNS N SC39-34NS N	

Teflon 特氟隆内釜

DLC 像鑽石一樣堅硬的石炭塗層内釜

Ti 鈦塗層

ADJ 护针片調整旋梭

N 附防止空轉彈簧片

WEIGHT AND MEASUREMENT TABLE (重量尺寸表)

ROTARY HOOK HIGH SPEED TYPE : KHS

KOBAN NO	N.W.	G.W.	G.W.	MEASUREMENT
	IPC.(G)	12PCS.(G)	360PCS.(G)	
KHS11S-58	62	782	24,000	26×43×25
KHS1183-SP	62	782	24,000	26×43×25
KHS12-2S	62	782	24,000	26×43×25
KHS12-G	62	782	24,000	26×43×25
KHS12-GP	62	782	24,000	26×43×25
KHS12-GTH	62	782	24,000	26×43×25
KHS12-GTHPD	62	782	24,000	26×43×25
KHS12-GTPN2D2	62	782	24,000	26×43×25
KHS12-GTPND2	62	782	24,000	26×43×25
KHS12-R	62	782	24,000	26×43×25
KHS12-RD	62	782	24,000	26×43×25
KHS12-RP	62	782	24,000	26×43×25
KHS12-RPN2D2	62	782	24,000	26×43×25
KHS12-RY	62	782	24,000	26×43×25
KHS12-RY3N	62	782	24,000	26×43×25
KHS12-RYN	62	782	24,000	26×43×25
KHS12-RYNW	62	782	24,000	26×43×25
KHS12-RYOE	62	782	24,000	26×43×25
KHS12-RYP	62	782	24,000	26×43×25
KHS12-RYPICC	62	782	24,000	26×43×25
KHS12-RYPN	62	782	24,000	26×43×25
KHS12-RYPNW	62	782	24,000	26×43×25
KHS12-RYPOE	62	782	24,000	26×43×25
KHS12-RYPOEOJ2	62	782	24,000	26×43×25
KHS12-RYPW	62	782	24,000	26×43×25
KHS12-S	62	782	24,000	26×43×25
KHS12-SB3OHO	62	782	24,000	26×43×25
KHS12-SD	62	782	24,000	26×43×25
KHS12-SJ2	62	782	24,000	26×43×25
KHS12-SJH	62	782	24,000	26×43×25
KHS12-SOHO	62	782	24,000	26×43×25
KHS12-SP	62	782	24,000	26×43×25
KHS12-SPA3	62	782	24,000	26×43×25
KHS12-SPB	62	782	24,000	26×43×25
KHS12-SPB3OHO	62	782	24,000	26×43×25
KHS12-SPD2	62	782	24,000	26×43×25
KHS12-SPD3	62	782	24,000	26×43×25
KHS12-SPD4	62	782	24,000	26×43×25
KHS12-SPD6	62	782	24,000	26×43×25
KHS12-SPD8CC	62	782	24,000	26×43×25
KHS12-SPNJW	62	782	24,000	26×43×25
KHS12-SPUNS	62	782	24,000	26×43×25
KHS12-SPW	62	782	24,000	26×43×25
KHS14-G	62	782	24,000	26×43×25

KOBAN NO	N.W.	G.W.	G.W.	MEASUREMENT
	IPC.(G)	12PCS.(G)	360PCS.(G)	
KHS14-GN	62	782	24,000	26×43×25
KHS14-R	62	782	24,000	26×43×25
KHS14-S	62	782	24,000	26×43×25
KHS14-SS	62	782	24,000	26×43×25
KHS271-S	62	782	24,000	26×43×25
KHS438	70	876	26,000	26×43×25
KHS480	70	876	26,000	26×43×25

ROTARY HOOK HIGH SPEED LARGE TYPE : KHS20

KOBAN NO	N.W.	G.W.	G.W.	MEASUREMENT
	IPC.(G)	6PCS.(G)	144PCS.(G)	
KHS20-GTB	84	540	13,000	22×30×29
KHS20-GTMP	84	540	13,000	22×30×29
KHS20-GTVG	84	540	13,000	22×30×29
KHS20-HPEW	84	540	13,000	22×30×29
KHS20-R	84	540	13,000	22×30×29
KHS20-RIE	84	540	13,000	22×30×29
KHS20-R2E	84	540	13,000	22×30×29
KHS20-RM2	84	540	13,000	22×30×29
KHS20-RM3	84	540	13,000	22×30×29
KHS20-RMP	84	540	13,000	22×30×29
KHS20-RMPCC	84	540	13,000	22×30×29
KHS20-RMPN	84	540	13,000	22×30×29
KHS20-RMPNW	84	540	13,000	22×30×29
KHS20-RPIECC	84	540	13,000	22×30×29
KHS20-RPE	84	540	13,000	22×30×29
KHS20-RPEM2A0	84	540	13,000	22×30×29
KHS20-RPNG	84	540	13,000	22×30×29
KHS20-RTB	84	540	13,000	22×30×29
KHS20-RY	84	540	13,000	22×30×29
KHS20-RYP	84	540	13,000	22×30×29
KHS20-RYPN	84	540	13,000	22×30×29
KHS20-S	84	540	13,000	22×30×29
KHS20-SMP	84	540	13,000	22×30×29
KHS20SPEM2ANG	84	540	13,000	22×30×29
KHS20-RT	84	540	13,000	22×30×29
KHS20-ST	84	540	13,000	22×30×29
KHS20-TZ	84	540	13,000	22×30×29
KHS30-RPNG	98	—	—	—

ROTARY HOOK LOW SPEED TYPE : KR

KOBAN NO	N.W.	GW.	G.W.	MEASUREMENT
	IPC.(G)	12PCS(G)	360PCS(G)	W×L×H(CM)
KR134	52	670	21,000	26×43×25
KR134Z	52	670	21,000	26×43×25
KR134ZICC	52	670	21,000	26×43×25
KR134ZVICC	52	670	21,000	26×43×25
KR18	62	782	24,000	26×43×25
KR21-G	52	670	21,000	26×43×25
KR21-GTPDE	52	670	21,000	26×43×25
KR21-R	52	670	21,000	26×43×25
KR21-RD	52	670	21,000	26×43×25
KR21-RPDE	52	670	21,000	26×43×25
KR21-S	52	670	21,000	26×43×25
KR23-16	52	670	21,000	26×43×25
KR234	52	670	21,000	26×43×25
KR238	48	600	19,000	26×43×25
KR238-14	48	600	19,000	26×43×25
KR24	52	670	21,000	26×43×25
KR24-B	52	670	21,000	26×43×25
KR24-RHPD	52	670	21,000	26×43×25
KR24-T	52	670	21,000	26×43×25
KR24-U	59	735	23,000	26×43×25
KR24U-31	59	735	23,000	26×43×25
KR24U-42	59	735	23,000	26×43×25
KR69	48	600	19,000	26×43×25
KR69-V	48	600	19,000	26×43×25
KR69-VP	48	600	19,000	26×43×25

ROTARY HOOK HIGH SPEED ZIGZAG TYPE : KRP

KOBAN NO	N.W.	GW.	G.W.	MEASUREMENT
	IPC.(G)	6PCS.(G)	144PCS.(G)	W×L×H(CM)
KRP41-B	58	380	9,500	22×30×29
KRP41-LH	56	366	9,000	22×30×29
KRP41-LH2	56	366	9,000	22×30×29
KRP41-LH3ICC	56	414	9,000	22×30×29
KRP41-R	56	366	9,000	22×30×29
KRP41-S	56	366	9,000	22×30×29
KRP457	64	414	10,000	22×30×29
KRP457JICC	64	414	10,000	22×30×29
KRP457JTI	64	414	9,000	22×30×29
KRP457-W	64	414	10,000	22×30×29
KRP457-W3	64	414	10,000	22×30×29
KRP800	64	414	10,000	22×30×29
KRP800BTI	64	414	9,000	22×30×29
KRP818ICC	64	414	10,000	22×30×29

KRP856TI	64	414	9,000	22×30×29
-----------------	----	-----	-------	----------

ROTARY HOOK STANDARD TYPE WITH SHAFT : KRT

KOBAN NO	N.W.	G.W.	G.W.	MEASUREMENT
	IPC.(G)	6PCS.(G)	72PCS.(G)	W×L×H(CM)
KRT11-5	85	557	7,000	19×26×28
KRT12-4	82	522	6,600	19×26×28
KRT12-5-19R	82	522	6,600	19×26×28
KRT12-5B	84	545	7,000	19×26×28
KRT12-5BF	84	545	7,000	19×26×28
KRT12-5BFCI	84	545	7,000	19×26×28
KRT12-5BFKC	84	545	7,000	19×26×28
KRT12-5BH	84	545	7,000	19×26×28
KRT12-5BHR	84	545	7,000	19×26×28
KRT12-5BK	82	522	6,600	19×26×28
KRT12-5J	82	522	6,600	21×30×31
KRT12-5JC	82	522	6,600	21×30×31
KRT12-5JCI	82	522	6,600	21×30×31
KRT12-5JI	82	522	6,600	21×30×31
KRT12-5JK-L	82	522	6,600	21×30×31
KRT12-5JK-R	82	522	6,600	21×30×31
KRT12-5JKC-L	82	522	6,600	21×30×31
KRT12-5JKC-R	82	522	6,600	21×30×31
KRT12-5M	88	560	7,000	19×26×28
KRT12-5MC	88	560	7,000	19×26×28
KRT12-5MCI	88	560	7,000	19×26×28
KRT12-5MK	82	522	6,600	19×26×28
KRT12-5R	90	573	7,500	19×26×28
KRT30JC	90	573	7,500	19×26×28
KRT30JCI	90	573	7,500	19×26×28
KRT842CI	90	573	7,500	19×26×28
KRT842FK-S	88	560	7,000	19×26×28
KRT842F-S	88	560	7,000	19×26×28
KRT842H-R	88	560	7,000	19×26×28
KRT842H-S	88	560	7,000	19×26×28
KRT842KC	88	560	7,000	19×26×28
KRT845BK	88	560	7,000	19×26×28

ROTARY HOOK LARGE TYPE WITH SHAFT : KRT

KOBAN NO	N.W.	G.W.	G.W.	MEASUREMENT W×L×H(CM)
	IPC.(G)	6PCS.(G)	72PCS.(G)	
KRT11-5LJKR	100	646	8,000	21×30×31
KRT11-5LJKS	100	646	8,000	21×30×31
KRT11-5LJR	104	674	8,500	21×30×31
KRT11-5LJS	104	674	8,500	21×30×31
KRT11-5LLJC-R	104	674	8,500	21×30×31
KRT12-5LBK2	104	674	8,500	21×30×31
KRT12-5LJH-R	104	674	8,500	21×30×31
KRT12-5LJK-L	102	650	8,000	21×30×31
KRT12-5LJK-R	102	650	8,000	21×30×31
KRT12-5LJKCL	102	650	8,000	21×30×31
KRT12-5LJKCR	102	650	8,000	21×30×31
KRT12-5LM	104	674	8,500	21×30×31
KRT12-5LMC	104	674	8,500	21×30×31
KRT12-5LMC-R	104	674	8,500	21×30×31
KRT12-5LMK	104	674	8,500	21×30×31
KRT12-5LMKC	104	674	8,500	21×30×31
KRT12-5LMKC-C	104	674	8,500	21×30×31
KRT12-5LMKC-CI	104	674	8,500	21×30×31
KRT12-5LMKC-CIV	104	674	8,500	21×30×31
KRT12-5LMR	104	674	8,500	21×30×31
KRT150LJC2ICC-R	104	674	8,500	21×30×31
KRT30LJ	104	674	8,500	21×30×31
KRT30LJC	104	674	8,500	21×30×31
KRT872L	112	720	9,000	21×30×31
KRT875LC	100	635	7,600	21×30×31
KRT875LK	100	635	7,600	21×30×31
KRT8-LCI2-S	116	746	9,000	21×30×31
KRT8-LCI-S	116	746	9,000	21×30×31
KRT8-LC-RB-CS	112	720	9,000	21×30×31
KRT8-LCR-CS	112	720	9,000	21×30×31
KRT8-LCS-CS	112	720	9,000	21×30×31
KRT-BL	104	658	8,300	21×30×31
KRT-BLC	104	658	8,300	21×30×31
KRT-LS2R	112	720	9,000	21×30×31
KRT-LS2S	112	720	9,000	21×30×31
KRT-LSR	112	720	9,000	21×30×31
KRT-LSRB	112	720	9,000	21×30×31
KRT-LSS	112	720	9,000	21×30×31

ROTARY HOOK STANDARD TYPE WITHOUT SHAFT : KRT

KOBAN NO	N.W.	G.W.	G.W.	MEASUREMENT W×L×H(CM)
	IPC.(G)	6PCS.(G)	144PCS.(G)	
KRT145	44	300	7,600	22×30×29
KRT145G	48	320	8,000	22×30×29
KRT151MO	46	312	8,000	22×30×29
KRT151S	46	312	8,000	22×30×29
KRT151SG	50	336	8,600	22×30×29
KRT18-R	48	320	8,000	22×30×29
KRT18-S	48	320	8,000	22×30×29
KRT190	46	312	8,000	22×30×29
KRT190G	50	336	8,600	22×30×29
KRT191	48	320	8,000	22×30×29
KRT19-R	50	340	8,600	22×30×29
KRT21	62	410	10,000	22×30×29
KRT236	48	320	8,000	22×30×29

ROTARY HOOK STANDARD TYPE WITHOUT SHAFT : KRT

KOBAN NO	N.W.	G.W.	G.W.	MEASUREMENT W×L×H(CM)
	IPC.(G)	6PCS.(G)	144PCS.(G)	
KRT31-11R	54	360	9,000	22×30×29
KRT31-11S	54	360	9,000	22×30×29
KRT31-11SG	65	440	11,000	22×30×29
KRT31MIN	50	336	8,600	22×30×29
KRT31-NR	55	372	9,000	22×30×29
KRT31-R	50	340	8,500	22×30×29
KRT31-RG	55	372	9,000	22×30×29
KRT31-S	50	340	8,500	22×30×29
KRT31-SG	55	372	9,000	22×30×29
KRT31-SKG	55	372	9,000	22×30×29
KRT345G	48	320	8,000	22×30×29
KRT390	48	320	8,000	22×30×29
KRT390G	52	344	8,600	22×30×29
KRT390-HBG	52	344	8,600	22×30×29
KRT391	52	344	8,600	22×30×29
KRT412-S	48	320	8,000	22×30×29
KRT470C2-R	68	444	11,000	22×30×29
KRT470C-R	68	444	11,000	22×30×29
KRT470C-S	68	444	11,000	22×30×29
KRT470MIN	50	336	8,600	22×30×29
KRT470-R	68	444	11,000	22×30×29
KRT470-RH	68	444	11,000	22×30×29
KRT470-RHB	68	444	11,000	22×30×29
KRT470-RHH	68	444	11,000	22×30×29
KRT470-S	68	444	11,000	22×30×29
KRT490-R	68	444	11,000	22×30×29

ROTARY HOOK STANDARD TYPE WITHOUT SHAFT : KRT

KOBAN NO	N.W.	G.W.	G.W.	MEASUREMENT W×L×H(CM)
	IPC.(G)	6PCS.(G)	144PCS.(G)	
KRT490-S	68	444	11,000	22×30×29
KRT51	48	320	8,000	22×30×29
KRT592V2-R	68	444	11,000	22×30×29
KRT67	44	300	7,600	22×30×29

ROTARY HOOK LARGE TYPE WITHOUT SHAFT : KRT

KOBAN NO	N.W.	G.W.	G.W.	MEASUREMENT W×L×H(CM)
	IPC.(G)	6PCS.(G)	144PCS.(G)	
KRT1242-R	68	444	11,000	22×30×29
KRT1242-S	68	444	11,000	22×30×29
KRT167	68	444	11,000	22×30×29
KRT211-L	74	472	11,700	22×30×29
KRT26-LPC	94	598	14,700	22×30×29
KRT26-LPC2	94	598	14,700	22×30×29
KRT31-LR	75	485	12,000	22×30×29
KRT341G	65	440	11,000	22×30×29
KRT341-NHI	68	444	11,000	22×30×29
KRT341-NR	68	444	11,000	22×30×29
KRT341-NS	68	444	11,000	22×30×29
KRT341SG	65	440	11,000	22×30×29
KRT467	157	1,034	—	—
KRT467L	145	1,067	—	—
KRT467XLI-R	164	1,184	—	—
KRT470LCI-R	63	—	—	—
KRT470LI-R	63	—	—	—
KRT545	60	390	9,700	22×30×29
KRT545G	66	430	11,000	22×30×29
KRT768I-ICC-R	64	452	11,248	22×30×29
KRT867XLI-R	141	1,065	—	—
KRT8-BL	86	570	13,500	22×30×29
KRT8-LPK	98	620	15,000	22×30×29
KRT8-LPK-2	98	620	15,000	22×30×29
KRT8-LPR	94	598	14,700	22×30×29
KRT8-LPS	94	598	14,700	22×30×29

ROTARY HOOK SPECIAL TYPE : KRT

KOBAN NO	N.W.	G.W.	G.W.	MEASUREMENT W×L×H(CM)
	IPC.(G)	6PCS.(G)	144PCS.(G)	
KRT132	324	2,058	—	—
KRT132-M	324	2,058	—	—
KRT132-MT	324	2,058	—	—
KRT132-SKZ	332	2,106	—	—
KRT133	324	2,058	—	—
KRT14-5	198	1,330	—	—
KRT14-5HP	198	1,330	—	—
KRT14-5-O	195	1,330	—	—
KRT14-5-O-C	195	1,330	—	—
CKRT132SET	72	—	—	—
CKRT133SET	72	—	—	—
OKRT132R	92	—	—	—
OKRT132SET	92	—	—	—
OKRT133R	92	—	—	—

SHUTTLE HOOK MISCELLANEOUS PARTS : KSP

KOBAN NO	N.W.	G.W.	G.W.	MEASUREMENT W×L×H(CM)
	IPC.(G)	6PCS.(G)	144PCS.(G)	
KSP204	80	—	—	—
KSP204H	80	—	—	—
KSP204N	80	—	—	—
KSP204NH	80	—	—	—
KSP360	20	—	—	—
KSP5934	60	—	—	—
KSP7-31	256	—	—	—
KSP7-9	98	—	—	—

CAP : SCP

KOBAN NO	N.W.	G.W.	G.W.	MEASUREMENT W×L×H(CM)
	IPC.(G)	50PCS.(G)	—	
SCP151MO	7	386	—	—
SCP167	12	636	—	—
SCP18	7	386	—	—
SCP18-2	7	386	—	—
SCP26-L	12	636	—	—
SCP31-K	8	436	—	—
SCP31MIN	7	386	—	—
SCP545	12	636	—	—
SCP67	8	436	—	—
SCP-842BC	8	436	—	—
SCP-842BK	8	436	—	—
SCP-842BKC	8	436	—	—

CAP : SCP

KOBAN NO	N.W.	G.W.	G.W.	MEASUREMENT
	IPC.(G)	50PCS(G)		W×L×H(CM)
SCP-BK	8	436	—	—
SCP-BL	12	636	—	—
SCP-BLP	12	636	—	—
SCP-JC	8	436	—	—
SCP-JKC	8	436	—	—
SCP-LBK	12	636	—	—
SCP-LBKC	12	636	—	—
SCP-LBKC(J)	12	636	—	—
SCP-LJ	12	636	—	—
SCP-LJK	12	636	—	—
SCP-LJKC	12	636	—	—
SCP-LLJ	12	636	—	—
SCP-LMC	12	636	—	—
SCP-LMK	12	636	—	—
SCP-LMKC	12	636	—	—
SCP-LMKC2	12	636	—	—
SCP-MC	8	436	—	—
SCP-MK	8	436	—	—
SCP-MK3	8	436	—	—
SCP-MKC	8	436	—	—
SCPF15	7	386	—	—
SCPF15H	7	386	—	—
SCPF19	7	386	—	—
SCPF441	7	386	—	—
SCPF572	7	386	—	—

BOBBIN CASE STANDARD TYPE : SC

KOBAN NO	N.W.	G.W.	G.W.	MEASUREMENT
	IPC.(G)	50PCS.(G)	1000PCS(G)	W×L×H(CM)
SC211	10	510	10,500	17×26×32
SC265	10	510	10,500	17×26×32
SC31	10	530	11,000	17×26×32
SC31-NS	10	530	11,000	17×26×32
SC34-1	9	500	10,300	17×26×32
SC34-1NS	9	500	10,300	17×26×32
SC34-2NS	9	500	10,300	17×26×32
SC35	9	500	10,300	17×26×32
SC35-NS	9	500	10,300	17×26×32
SC35-T	9	500	10,300	17×26×32
SC38	10	530	11,000	17×26×32
SC39	10	530	11,000	17×26×32
SC39-14	9	500	10,300	17×26×32
SC39-14NS	9	500	10,300	17×26×32
SC39-34NS	9	500	10,300	17×26×32

SC39-NS	10	530	11,000	17×26×32
SC639	10	530	11,000	17×26×32
SC81-2	10	530	11,000	17×26×32
SC81-2NS	10	530	11,000	17×26×32
SC81-2NS2	10	530	11,000	17×26×32
SC82-J	9	500	10,300	17×26×32
SC82-JNS	9	500	10,300	17×26×32
SC82-JNS2	9	500	10,300	17×26×32
SC83	9	500	10,300	17×26×32

BOBBIN CASE LARGE TYPE : SC

KOBAN NO	N.W.	G.W.	G.W.	MEASUREMENT
	IPC.(G)	20PCS.(G)	500PCS(G)	W×L×H(CM)
SC33-LB	15	360	9,300	—
SC33-LD	15	360	9,300	—
SC33-LDH	15	360	9,300	—
SC33-LM	15	360	9,300	—
SC33-LNS	15	360	9,300	—
SC33-LNS3	15	360	9,300	—
SC33-LNSH	15	360	9,300	—
SC34-L	16	370	9,500	—
SC34-LHNS	16	370	9,500	—
SC34-LNS	16	370	9,500	—
SC34-LZNS	16	370	9,500	—
SC35-L	15	360	9,300	—
SC35-LNS	16	370	9,500	—
SC35-XLNS	21	—	—	—
SC369	16	370	9,500	—

BOBBIN CASE SPECIAL TYPE : SC

KOBAN NO	N.W.	G.W.	G.W.	MEASUREMENT
	IPC.(G)	20PCS.(G)	500PCS(G)	W×L×H(CM)
SC181	16	380	—	—
SC181H	16	380	—	—
SC430	12	280	7,300	—
SC70-2	12	280	7,300	—
SC70-27	12	280	7,300	—
SC70-2M	12	280	7,300	—
SC70-2NS	12	280	7,300	—
SC70-3	12	280	7,300	—
SC70-31	12	280	7,300	—
SC70-3FL	12	280	7,300	—
SC70-3JNS	12	280	7,300	—
SC70-3M	12	280	7,300	—













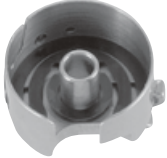



BOBBIN CASE SPECIAL TYPE : SC

KOBAN NO	N.W.	G.W.	G.W.	MEASUREMENT
	1PC.(G)	20PCS.(G)	500PCS(G)	W×L×H(CM)
SC70-3NS	12	280	7,300	—
SC70-3TNS	12	280	7,300	—
SC70-3WFLNS	12	280	7,300	—
SC70-LH3NS	12	280	7,300	—
SC70-771	12	280	7,300	—
SC70-771NS	12	280	7,300	—
SC980N	12	280	7,300	—
SC980-2	12	280	7,300	—

SHUTTLE HOOK : SH

KOBAN NO	N.W.	G.W.	G.W.	MEASUREMENT
	1PC.(G)	12PCS.(G)	360PCS(G)	W×L×H(CM)
SH181	18	301	9,530	26×43×25
SH181H	18	301	9,530	26×43×25
SH280	17	287	9,280	26×43×25
SH280T	17	287	9,280	26×43×25
SH282	17	287	9,280	26×43×25
SH31	17	287	9,280	26×43×25
SH430	17	287	9,280	26×43×25
SH430-D	17	287	9,280	26×43×25
SH430-H	17	287	9,280	26×43×25
SH51	17	287	9,280	26×43×25
SH570	17	287	9,280	26×43×25
SH61	17	287	9,280	26×43×25
SH61-NG	17	287	9,280	26×43×25
SH61CR	17	287	9,280	26×43×25
SH-P1	17	287	9,280	26×43×25
SH-P2	17	287	9,280	26×43×25
SH311A	17	287	9,280	26×43×25
SH311B	17	287	9,280	26×43×25

NON SLIP SPRING : NS (防止空转弹簧片)

		Art. No.	Bobbin Cases
		NS180	SC181 SC181H
		NS31	SC31-NS SC35-NS SC81-NS SC82-NS SC83-NS SC82-JNS SC81-2NS SC211
		NS31-L	SC31-LNS SC34-LNS SC34-LHNS
		NS39	SC39-NS SC39-14NS SC39-7NS
		NS33-LD	SC33-LD SC33-LNS3
		NS33-LB	SC33-LB SC34-LZNS SC35-LB SC369
		NS33-L	SC33-LNS
		NS205	SC205
		NS70	SC70-1NS SC70-2NS SC70-3NS SC70-12NS SC70-31NS SC70-771NS

COMPONENT PARTS (构成零件)

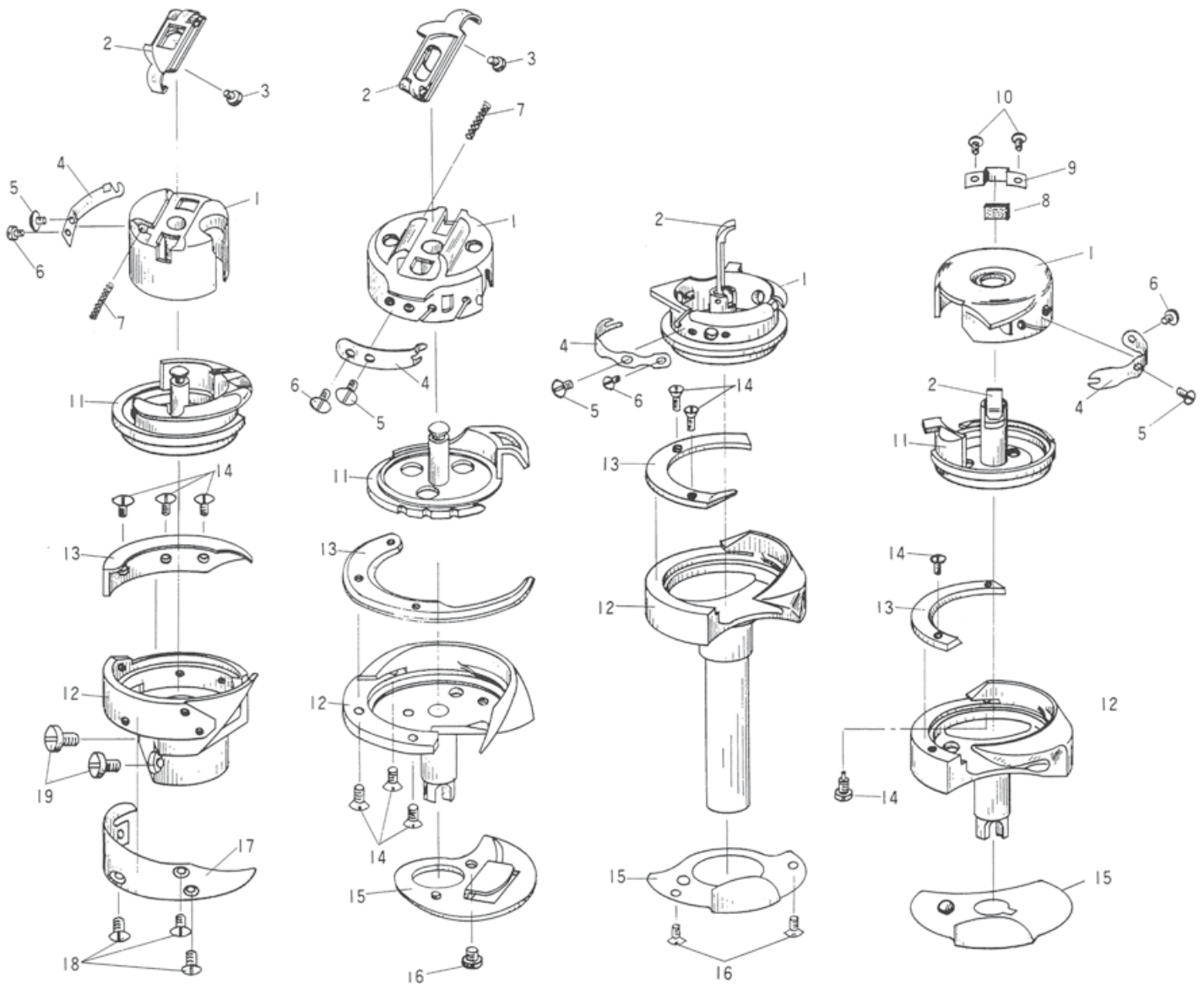

- | | |
|---------------------------------|---------------------------------------|
| 1 Bobbin Case Body (梭壳本体) | 11 Hook Base & Bobbin Case Base (内旋梭) |
| 2 Latch (提纽) | 12 Hook Body (外旋梭) |
| 3 Latch Screw (提纽固定螺丝) | 13 Gib (旋梭压板) |
| 4 Tension Spring (张紧弹片) | 14 Gib Screw (旋梭板固定螺丝) |
| 5 T.S. Regulating Screw (调节螺丝) | 15 Hook Washer & Needle Guard (护针片) |
| 6 T.S. Securing Screw (紧固螺丝) | 16 H.W. Screw & N.G. Screw (护针片固定螺钉) |
| 7 Latch Spring (环形弹片) | 17 Thread Guard (外弹片) |
| 8 Green Felt (绿色毛毡) | 18 Thread Guard Screw (外弹片固定螺丝) |
| 9 Felt Holder (毛毡支撑) | 19 Hook Set Screw (安装螺丝) |
| 10 Felt Holder Screw (毛毡支撑固定螺丝) | |

VARIETIES OF HOOK GIBS (旋梭压板的种类)

Koban Hook has three types of gibs suitable for various kinds of materials, being R, S, and G as mentioned below.

(佐文牌梭 ‘R’ ‘S’ ‘G’ 三种旋梭压板的各种料缝纫条件)

R=Short gib for heavy materials. (短旋梭压板型, 厚料用)

S=Long gib for light materials. (长旋梭压板型, 薄料用)

G=Tacking gib for general materials. (中间旋梭压板型, 一般厚料用)

We indicate the above letters in our Article No. (上記说明文字中使用了我司的制品名称)

For instance : KHS12-R , KHS12-S , KHS12-G , KRT8-LPR , KRT8-LPS

(例如 KHS12-R , KHS12-S , KHS12-G , KRT12-5R , KRT31-S)

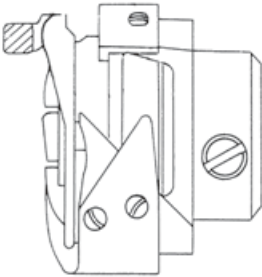
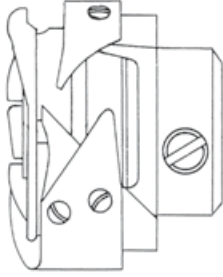
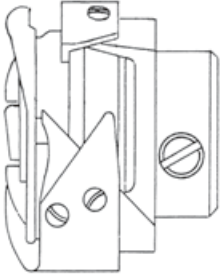
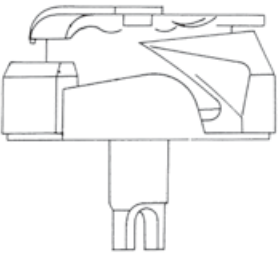
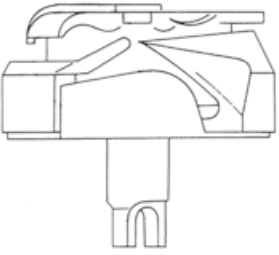
R Type	S Type	G Type
		
		

INNOVATION FOR EMBROIDERY



SC34-2NS

High Durability

No Bent or No Broken like a pig tail spring

Secure Thread Trimming

Thread can be always in right position for thread trimming.
(Bent a pig tail spring causes miss thread trimming)

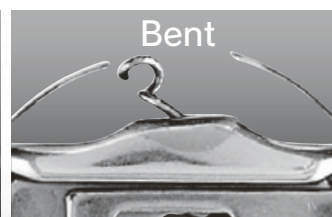
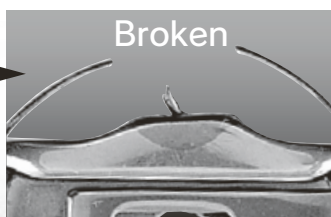

Embroidery Hooks Line Up

Rotary Hook	Reference
KHS12-RYP	Common type
KHS12-RYPICC	DLC hook base
KHS12-RYPO2ICC	DLC hook base and lubrication
KHS12-RYPOEOJ2	Eccentric, lubrication
KHS12-RYPOEICC	Eccentric, DLC hook base
KR134ZICC	DLC hook base

DLC Coating (像钻石一样坚硬的石炭)

(Diamond Like Carbon)



LEADING MODELS (例如如下商品)

KHS12-SPD2ICC

HIGH SPEED AUTO TRIMMER with DLC Base
(高速平缝自动切线机用内梭DLC加工)

KHS12-RYPICC

EMBROIDARY with DLC Base
(自动切线刺绣用, 内梭DLC加工)

KRP457JICC

ZIGZAG with DLC Base
(曲折缝, 内梭DLC加工)

KRP800BICC

BUTTON HOLING with DLC Base
(锁纽扣用, 内梭DLC加工)

KRT842KCICC

BROTHER TWO NEEDLE with DLC Base
(兄弟, 双针用, 内梭DLC加工)

KRT875LKICC

BROTHER TWO NEEDLE with DLC Base
(兄弟, 双针用, 内梭DLC加工)

- ※Low friction.
(低摩擦力)
- ※High heat resistance.
(耐热性)
- ※High durability.
(高耐久力)
- ※Minimal oiling.
(可以最小给油(微量给油))

ADJUSTABLE STRONG NEEDLE GUARD (护针片调整旋梭)

PATENTED (特许)



LEADING MODELS (例如如下商品)

SKRT592V2-R

PFAFF STANDARD TYPE WITHOUT SHAFT
(百福)

KRT12-5LMKC-CIV

MITSUBISHI TWO NEEDLE
(三菱, 双针)

KRT872LV

BROTHER TWO NEEDLE
(兄弟, 双针)

- ※Easy adjustable needle guard.
(简单调整护针片)
- ※More than 7 times stronger needle guard protects the hook tip from needle hitting.
(比以往护针片强7倍的强度保护与针接触的梭尖)

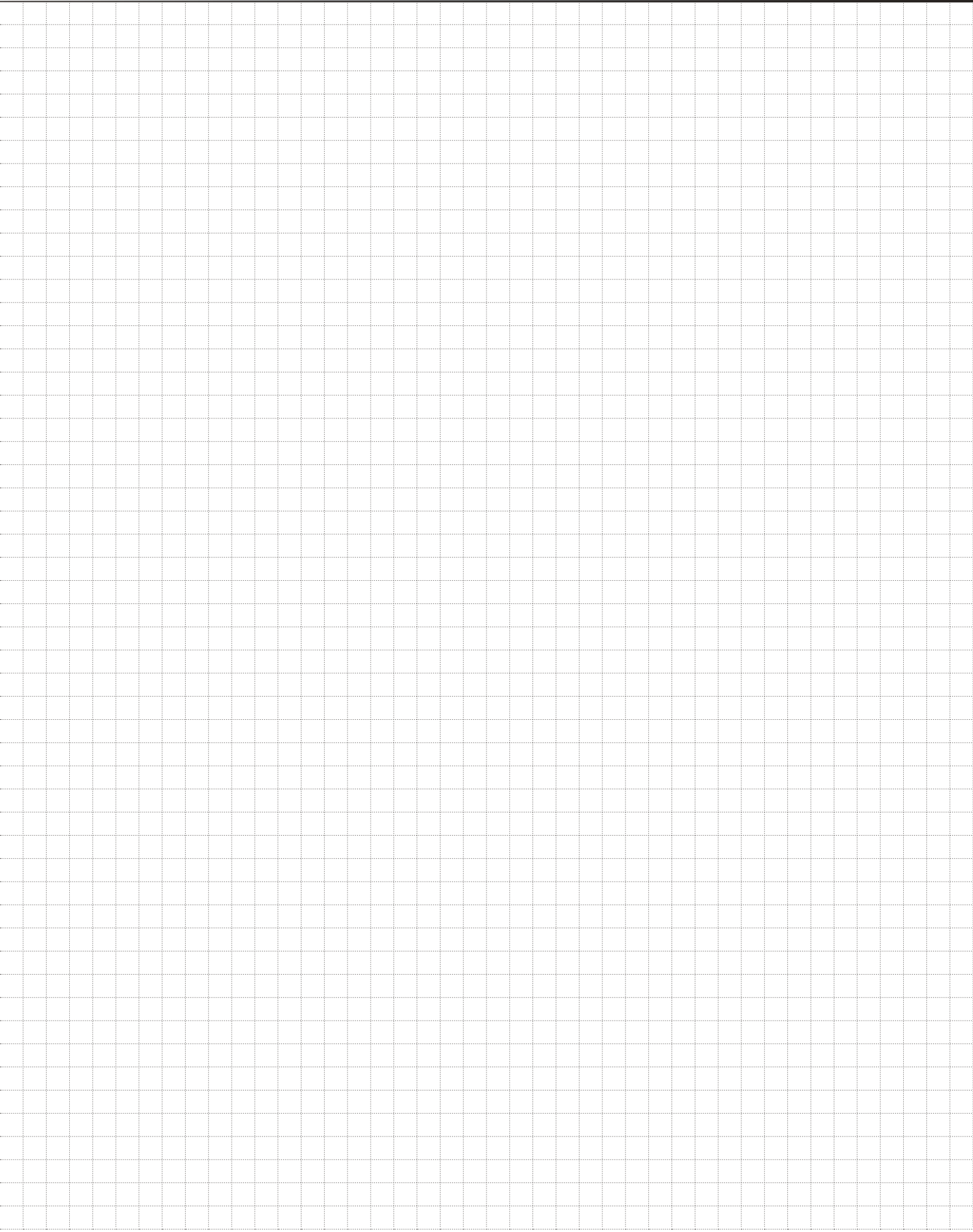





SABUN INDUSTRIAL CO., LTD.
JAPAN



<https://sabun.co.jp/english/>

株式
會社

佐文工業所 日本